

**INTERNATIONAL  
CROSSBOW SHOOTING  
UNION**



**FIELD DIVISION**

**COMPETITION RULES  
2<sup>nd</sup> March 2026**



# IAU COMPETITION RULES FIELD CROSSBOW

## Table of Contents

Article No		Page
	Abbreviations	4
	Definitions	5
Article 301	International Competitions	7
Article 302	Official Functions and Ceremonies	10
Article 303	Team and Individual Competitions	11
Article 304	Rights of Participation and Citizenship	13
Article 305	Doping Control	14
Article 306	Competition Entrance Fees	16
Article 307	Competition Invitations and Entry Forms	18
Article 308	International Competition, Titles and Awards	19
Article 309	International Competition Results	22
Article 310	Records	22
Article 311	International Judges	23
Article 312	Field Judges	25
Article 313	Official Scorers, Results and Scoreboards	26
Article 314	Outdoor Field Layout	27
Article 315	Indoor Layout	32
Article 316	Field Equipment Specifications	35
Article 317	Target Faces	38
Article 318	International Target Rounds	40
Article 319	Target Assignment & Competitor Numbers	41
Article 320	Practice	43
Article 321	Time Control and Signals	45



# IAU COMPETITION RULES FIELD CROSSBOW

---

Article 322	Shooting Position	48
Article 323	Sighting Shots	50
Article 324	Competition Shots	51
Article 325	Scoring	53
Article 326	Target Crossbow Limits	57
Article 327	Bolt Specification	63
Article 328	Equipment Failure, Repairs and Interference	64
Article 329	Optical Aids	65
Article 330	Clothing and Personal Equipment	66
Article 331	Heraldry	69
Article 332	Safety and Courtesy	69
Article 333	Assistance and Coaching	72
Article 334	Equipment control	72
Article 335	Disciplinary Action	74
Article 336	Protests, Appeals and Higher Appeals	75
Article 337	Precedence, Interpretation and Amendments	76
Article 338	WC/RC Administration	76
Article 339	Advertising and Sponsorship	76
Article 350	IAU Match Play Round	78
Article 351	World Cup Finals 35m/18m rules	87
Article 360	IAU Rank List, World Cup and World Cup Final	95
Annexes		98
Article 370.1	IAU Identification Number (IAU ID Number)	103
Article 370.2	IAU Crossbow Shooter-Declaration	106
Article 370.3	Agreement with the National sports federations	107
Article 370.4	Application form for an IAU official Competition	121
Article 370.5	Application form for IAU Field judges, licence issuing and renewing	123
End		123



# IAU COMPETITION RULES FIELD CROSSBOW

---

## Abbreviations

<b>cca.</b>	Approximately
<b>CE</b>	Cup Events
<b>DOS</b>	Director of Shooting
<b>FC</b>	Field Captain
<b>FJ</b>	Field Judge
<b>WA</b>	World Archery
<b>IAU</b>	Internationale Armbrustschützen Union
<b>IAU EC</b>	Executive Committee
<b>IC</b>	International Championships
<b>IJ</b>	International Judge
<b>IJC</b>	International Judges Committee
<b>ISSF</b>	<b>International Sport Shooting Union</b>
<b>IOC</b>	International Olympic Committee
<b>NTM</b>	National Team Manager
<b>OC</b>	Organizing Committee
<b>CCH</b>	<b>Continental</b> Championships
<b>SFr.</b>	Swiss Francs
<b>T</b>	Tournament
<b>TC</b>	Technical Committee
<b>VTCS</b>	Visual Time Control System
<b>WCH</b>	World Championships



# IAU COMPETITION RULES

## FIELD CROSSBOW

### Definitions

<b>Athlete</b>	crossbow shooter (competitor)
<b>Bolt</b>	the projectile shot from a crossbow (also arrow)
<b>Butt</b>	the target backstop
<b>Catch</b>	that part of the trigger mechanism which holds the string of a spanned crossbow (also latch, claw)
<b>Cock</b>	the act of setting the trigger mechanism, preparatory to spanning the crossbow
<b>Division</b>	either the Match or Field Division of the <b>IAU</b> , depending on context
<b>Confederation</b>	any grouping of <b>IAU</b> federations, controlling a geographic region
<b>Federation</b>	any member association, federation, union or otherwise of the <b>IAU</b> Field Division, representing a country
<b>Field</b>	relates to the shooting field
<b>Field Division</b>	the Field Division of the <b>IAU</b>
<b>Hanger</b>	a bolt which is hanging from the target face
<b>Load</b>	the act of placing a bolt into a spanned crossbow
<b>Prod</b>	that part of the crossbow which stores energy to be released to propel the bolt (also lath, bow, limbs)
<b>Rebound</b>	a bolt which has hit the butt/face and bounced back from the target
<b>Region</b>	European, Asian, Americas, etc. (may be controlled by a Continental Confederation)
<b>Relay</b>	that group of shooters currently shooting together
<b>Sanctioned</b>	an international Competition recognized by the <b>IAU</b> (event)
<b>Span</b>	the act of drawing the string of a braced crossbow so as to engage the catch



# IAU COMPETITION RULES FIELD CROSSBOW

---

## **Certified devices**

The IAU recognizes the current ISSF testing devices as specified in these competition rules (see Art.330.3).

Specific IAU devices (prod weigh control, templates for target faces, Electronic Scoring equipment for Finals, Support Stand for shooters with disabilities, etc.) must be certified by a Field Technical Committee as conforming to the approved specifications and/or methods of use.

## **Other IAU publications**

**IAU Constitution**

**Judges' Guidelines**

**Guidelines for Organizers of IAU Field Crossbow WCH or CCH**

**Guidelines for Cup Events**

**Prerequisites for Hosting World Championships**



# IAU COMPETITION RULES FIELD CROSSBOW

---

## Art. 301 INTERNATIONAL COMPETITIONS

The IAU recognizes the following competitions:

### **Hierarchy    Abbr.    Sanctioned By**

World Championships	<b>WCH</b>	IAU
Continental Championships	<b>CCH</b>	IAU
World Cup	<b>WC</b>	IAU
World Cup Final	<b>WCF</b>	IAU
Continental Cup	<b>RC</b>	Region and IAU
International Competitions	<b>IC</b>	Federation and IAU
Cup Events	<b>CE</b>	Federation and IAU
National Championships	<b>NT</b>	Federation
Tournaments	<b>T</b>	Clubs and Federations



# IAU COMPETITION RULES FIELD CROSSBOW

---

## Preamble

For the prerequisites for being considered to host **WCH, CCH, WC and WCF**, refer to separate publication “**Guidelines for Organizers of World and Continental Championships**”.

Federations desirous of hosting **WCH** must have successfully conducted a **CCH, CE or IC**.

Granting of **WCH** will follow the principle of Continental rotation such as Europe, Asia, Americas, Europe, etc. as far as is possible.

Host candidates for **WCH, CCH, WC and WCF** are requested to prepare a formal written proposal to the **EC** via an **Application form for an IAU official competition. Article 370.4** (The draft of this Application is available on the IAU website: <https://www.iau-crossbow.org>)

Consideration must be made for full teams from all member or associate federations, venue details as size, location, number of targets/ competitors, shooting direction, safety, accommodation, transport and administrative support arrangements, a detailed budget including sponsorship, government support, manpower, officials and experience.

Written submission shall be voted upon by the Field Division delegates present at **IAU General Assembly**, or **EC IAU**, on the basis of both signed **Agreement with the National Sport Federation as an organizer of IAU competition. Article 370.3** (The draft of this Agreement is available on the IAU website: <https://www.iau-crossbow.org>)



# IAU COMPETITION RULES

## FIELD CROSSBOW

- 301.1 IAU Championship shall be conducted in accordance with these Rules. Host federations will be determined according to the following criteria:
- 301.1.1 At WCH there must be at least seven (7) federations represented. The WCH will take place every two (2) (odd years).  
No WCH (but RC) the Olympic Games Years.  
For initialization: CCH in 2013 and 2016, WCH in 2014 and 2015, then normal rhythm: CCH in 2018 and 2020, WCH in 2017 and 2019
- 301.1.2 At CCH there must be at least five (5) federations present, although not necessarily from the IAU Region in question, i.e., European Championships, 5 European countries. CCH may be conducted every two (2) years for the IAU Regions of Europe, The Americas and Asia (including Pacific).
- 301.2 There shall be two (2) classes of other International Competition (non-title) as follows:  
Cup Events (CE) and International Competitions (IC)
- 301.2.1 CE and IC events are intended to allow maximum possible participation from as many federations as possible at modest cost. CE and IC events are intended to provide a vehicle to develop shooters in an international environment, and to develop the organization ability of federations in the conduct of international events.
- 301.2.2 There shall be a maximum of three (3) CE events per region per annum as a Continental Cup (Euro Cup, Asia Cup...) with at least three (3) countries from that Region, if possible (Art. 301.1.2), participating.
- 301.2.3 The World Cups shall be organized a maximum of four (4) events per annum with at least five (5) countries.  
World Records shall be recognized at CE events, subject to the Rules for the Conduct of CE being complied with (Art. 310). The event must be sanctioned by the IAU EC.
- 301.4 WCH, CCH, WC and WCF Championships may be held in conjunction with the 10 and 30 meters World Match or Continental Championships.



# IAU COMPETITION RULES

## FIELD CROSSBOW

- 301.5 WCH, CCH, WC and WCF Indoor Championships: The IAU may recognize applications from member federations seeking to organize WCH and/or CCH championships for indoor shooting. Such competitions shall be conducted in accordance with these Rules, according to the following criteria:
- 301.5.1 At WCH (Indoor) there must be at least seven (7) federations represented. The WCH may take place every two (2) (even years), but not more frequently.
- 301.5.2 At CCH (Indoor) there must be at least five (5) federations present, although not necessarily from the IAU region in question, i.e., European Championship, 5 European countries. The CCH may be conducted every two (2) years for the IAU Regions of Europe, The Americas and Asia (including Pacific).
- 301.5.3 The matter for WC and WCF is specified in the articles 351 and 360.

### **Art. 302 OFFICIAL FUNCTIONS AND CEREMONIES**

- 302.1 Reception: At WCH, CCH, WC and WCF a reception of the official representatives of the participating federations and representatives of the IAU by an official of the community should take place, if possible.
- 302.2 Opening Ceremony: At the beginning of the WCH or CCH, the IAU Flag will be ceremoniously handed over to the Organizing Committee (OC) who shall then conduct a flag raising ceremony. Competitors and officials should march on and off the field and stand as teams on the field during the ceremony. The OC may provide cultural or other entertainment as it considers appropriate.
- 302.3 Awards Ceremony: The President of the IAU or his representative shall conduct the presentation of awards at a suitable ceremony on the shooting field. National Crossbow Federation flags shall be allowed. National anthems may be played at the awards ceremony.
- 302.3.1 Distribution of Special Prizes: Such prizes, e.g., Participation Medals, shall be distributed at the Awards Ceremony after the presentation of the main awards.
- 302.4 Closing Ceremony: After the Awards Ceremony has been



# IAU COMPETITION RULES

## FIELD CROSSBOW

finished, the IAU Flag shall be ceremoniously lowered and handed back to the EC of the IAU for storage.

### **Art. 303 TEAM AND INDIVIDUAL COMPETITIONS IAU Classic**

303.1 At WCH, CCH, WC and WCF, Team and Individual competitions will be conducted in accordance with these Competition Rules. Refer also to separate documents “Guidelines for Organizers of IAU Championships” and “Guidelines for IAU Cup Events”.

303.2 IAU Classic Team Competitions: Each federation has the right to enter seven (7) teams, which will be made up only of Nationals from that country. The constitution of teams shall be:

MEN:	Three (3) competitors
WOMEN:	Three (3) competitors
JUNIORS:	Three (3) competitors (either sex)
CADETS:	Three (3) competitors (either sex)
SENIOR MEN:	Three (3) competitors
SENIOR WOMEN:	Three (3) competitors
ASSISTED:	Three (3) competitors (either sex)

303.2.1 The Team and Individual Competition shall be not organized in category, where is less than 6 (six) competitors. These competitors may shoot in the category a level higher (i.e.: Senior women in category Women, Senior men in category Men, Cadets in category Juniors, Juniors in category Men or Women by the sex, women in category Men).

303.3 Substitute Competitors: Federations may select members as team reserves. They must be listed by name and substituted in order of listing. Such substitutes may only be made with the consent of the IAU Field TC. No substitutions will be permitted after the start of the first Competition round.



# IAU COMPETITION RULES

## FIELD CROSSBOW

- 303.4 **Individual Competitors:**
- 303.4.1 Each participating national or associate Federation has the right to enter one (1) IAU Classic Team consisted of three Shooters (see article 303.2) and further one individual Competitor in every category.
- 303.4.2 Federation, which does not have enough competitors to enter a full team, may enter individual competitors.
- 303.4.3 The reigning individual World and Continental (continent) Champions (article 308.2) have to right to participate in the next WCH, CCH, WC and WCF as individual competitors, in addition to the maximum team size restrictions.
- 303.5 **Individual Competitions:**
- In Individual Competition are registered all Team members. Scores from the team events and results of one (1) individual Competitor (article 303.4.1) are used to determine the individual results.
- 303.6 **Juniors and Cadets:**
- Competitors, they have not attained the age of 23 years in first Competition Day, they may compete in category Cadets or Juniors (either sex).
- 303.6.1 Competitors, they have not attained the age of 18 years in first Competition Day, they may compete in category Cadets (either sex).
- 303.6.2 Competitors, they have not attained the age of 23 years in first Competition Day, but attained the age of 18 years, they may compete in category **Juniors** (either sex) (article 308.2.1).
- 303.7 **Seniors:** Competitors, they had reached the age of 50 years on or before the first day of the Competition they may compete in categories Senior men and Senior women. Each national or associate federation may enter up to three (3) competitors in the Seniors Individual event.
- 303.8 **Team and Individual Competitions IAU Classic Round:** WCH, CCH, WC and WCF will be decided on an IAU Classic Round: first day of Competition according to these Competition Rules. Men, Women, Juniors, Cadets, Men senior, Women senior



# IAU COMPETITION RULES

## FIELD CROSSBOW

and Assisted Shooters shall shoot together, competing for separate team and individual titles and awards.

At Indoor WCH, CCH, WC and WCF it will be decided on the respective round shot at 18 meters IR 600 round.

303.8.1 **Team and Individual Competition in IAU Match Play Round:** WCH, CCH, WC and WCF shall be decided on second and third day of competition according to Field division Competition Rules Art. 350, IAU Match Play Round

303.9 **Team Officials:** Each participating National Team shall be represented by a National Team Manager (NTM). A NTM may be a competitor or non-competitor. The NTMs shall generally represent their team in all matters pertaining to the championships. The NTMs shall:

- a. contact the OC as soon as possible after arrival,
- b. attend Team Managers' Meetings as necessary, and,
- c. accompany their teams during equipment control.

The NTMs shall represent their teams in the event of disputes either to the OC or the International Judges Committee (IJC). Each National Team may also be represented by an Assistant.

Team Manager (Coach).

One person may act simultaneously as NTM for not more than two (2) federations.

### Art. 304 RIGHTS OF PARTICIPATION AND CITIZENSHIP

304.1 Only teams and individuals who belong to a Federation which is either a member of the IAU (or Associate Member), or a member of the WCSA with an IAU ID number, and which has fulfilled all its obligations to the IAU (or WCSA) shall participate in IAU sanctioned events.

304.2 **Eligibility:** To be eligible to participate as a Member of a National Team in IAU sanctioned events, an athlete must have in his possession a valid passport from the country of which he is a National Team Member; or if he is to be a Member of another National Team, he must have resided in the new country for at



# IAU COMPETITION RULES

## FIELD CROSSBOW

---

least one year and must have the written permission of the member federation, if any, of the country from which he has a valid passport. Nationals of the host federation, who do not have a valid passport, must provide alternative proof of Citizenship or Residency to the satisfaction of the TC.

304.2.1 Team officials participating in the Championships must abide by these Rules.

304.3 **Guest Competitors:** At WCH, CCH, WC and WCF, only competitors from countries that are not yet members of the IAU (or Associate Members) may be invited to participate as Guests. Such invitations can only be made by the IAU Executive Committee. Guest competitors may be individuals or complete teams and are eligible for special awards.

The Participation of a Guest competitor shall not disadvantage the bona-fide IAU Member Federations whose competitors shall take priority with regard to target availability.

All Guest competitors shall be assessed for competency, safety and knowledge of these rules to the satisfaction of the IAU Field TC.

### Art. 305 DOPING CONTROL

305.1 At IAU sanctioned events, Doping Control will be at the request of the IAU Executive Committee or the host OC. The laboratory and control center facilities performing doping analysis must be approved by the Medical Commission (Doping Control Unit) of the host federation's National Olympic Committee and their guidance accepted through the official channels. The host OC is responsible for meeting the costs of drug testing. The IAU will pay the cost of a new WCH or CCH anti-doping control for a shooter not in the anti-doping list.

The number of tests to be taken will be specified by the IAU EC. At IAU sanctioned Events WCH or CCH the winners in Men and Women category will be taken. One additional test will be taken by draw, between winners in categories Juniors, Cadets, Senior men and Senior women.





# IAU COMPETITION RULES

## FIELD CROSSBOW

- 305.2 Doping: is the use by and/or distribution to a competitor of certain substances which could have the effect of artificially improving the competitor's physical and/or mental condition and thereby enhance his performance as an athlete. Doping is forbidden in crossbow shooting whenever shooting for IAU purposes.
- Doping substances NOT PERMITTED include drugs on the current list issued by the IOC and published by the IAU, e.g.
- This concerns BENZODIAZAPINES or any different drugs or groups of products which the medical committee of the CIO would add to the existing list.
- 305.3 Medical Provisions: athlete competing in IAU sanctioned events must agree to submit to such medical tests or examinations as may be required by the IAU, by the Organizers of the event or by the laws of the country in which the event takes place.
- 305.4 Shooter Declaration: Each participating athlete will be required to sign a Declaration confirming their awareness of the IAU's prevailing Doping Control regulations and penalties. The form of wording of such Declaration shall be as determined by the IAU Executive Committee (see annex). The signed Shooter declaration is an integral part of the application for issuing the IAU Identification Number. (See page 106)
- Officials' Declaration: The NTM is responsible for each competitor shall be required to countersign all appropriate Shooter Declarations.
- 305.5 Medical Tests: Any competitor refusing to take the required medical tests or proved to have broken these Doping Control provisions shall be DISQUALIFIED. The duration of such disqualification shall be determined by the IAU EC. Any Records or Championship Titles won by such athlete shall be returned for re-distribution. Accreditation shall be withdrawn from any official found guilty of breaking these rules. Any such occurrences shall be reported to the IAU EC by the federation responsible for the organization of the event.
- 305.6 Drug Test Results: The host OC shall submit copies of the official Drug Test Results to the Chairman of the Field TC within one (1) month of the Competition.





# IAU COMPETITION RULES FIELD CROSSBOW

## **Art. 306**

### **COMPETITION ENTRANCE FEES**

306.1

(1) The Participants shall pay to the IAU, participation fees for the participation in the Championship in accordance with the decision of the IAU Executive Committee, Strasbourg, October 7, 2023.

(2) A fee of EUR 150 - World and Continental Championships, EUR 100 - World Cup Field and Match and World Cup Final shall be paid for the participation of each athlete in each competition. A fee of 50 EUR for officials (team leaders, coaches, accompanying persons) shall be paid (Strasbourg, October 7, 2023),

The last day of registration for the IAU controlled competition is two weeks before the first day of the competition. Late registration will be charged with 50 EUR per person.

All Entry fees (except for World Cup Final) will be paid to the IAU account no later than 7 days before the start of the competition.

The total amount, reduced by EUR 30 per competitor, must be transferred from IAU to the organizers of the competition within 10 working days after the start of the competition.

306.1.1

No competitor shall be permitted to take part in any Competition unless the appropriate fee has been received by the IAU by not later than the evening before the first day of the Competition.



# IAU COMPETITION RULES FIELD CROSSBOW

## Summary of fees for the International Crossbow Shooting Federation

No	The name of the expenses	Amount	Payment for
1	2	3	4
1	Entry Fee WCH and CCH	150,00 €	To IAU account
1.1	Transferred Entry Fee WCH and CCH from IAU to OO within 10 working days after start of the competition	120,00 €	To OO account
2	Entry Fee WC	100,00 €	To IAU account
2.2	Transferred Entry Fee WC from IAU to OO within 10 working days after start of the competition	70,00 €	To OO account
3	Entry Fee WCF	100,00 €	To OO account
4	Entry Fee for each Official WCH, CCH, WC	50,00 €	To IAU account
4.4	Transferred Entry Fee for each Official WCH, CCH, WC from IAU to OO within 10 working days after start of the competition	50,00 €	To OO account
5	Entry Fee for each Official WCF	50,00 €	To OO account
6	Late Entry Fee WCH, CCH, WC (two weeks before the first day of the competition)	50,00 €	To IAU account
6.1	Transferred Late Entry Fee WCH, CCH, WC from IAU to OO within 10 working days start of the competition	50,00 €	To OO account
7	Late Entry Fee WCF (two weeks before the first day of the competition)	50,00 €	To OO account
8	Protest Fee in competitions	50,00 €	To OO account
9	IAU Judge license	20,00 €	To IAU account
10	IAU Judge license for reaccreditation	10,00 €	To IAU account
11	Issue for Athletes ID Numbers	10,00 €	To IAU account
12	Issue of Athletes ID Numbers Express application (Issue within one week)	20,00 €	To IAU account
13	Participation Fee in IAU Training Academy	120,00 €	To IAU account
14	Participation Fee in IAU Judge Course	70,00 €	To IAU account
15	Lecturer on the Training Academy or Judge Course per day of lectures (more than 5 hours a day)	120,00 €	To IAU account
16	Lecturer on the Training Academy or Judge Course per day of lectures (less than 5 hours a day)	60,00 €	To IAU account
17	Annual IAU Membership Fee per IAU Division (Field or Match)	100,00 €	To IAU account
18	The Organizing Committee must reimburse the travel costs for the official designated Jury Members to a maximum of	600,00 €	To Jury members
19	The Organizing Committee must reimburse the pocket money for the official designated Jury Members per day of the competition	25,00 €	To Jury members



# IAU COMPETITION RULES

## FIELD CROSSBOW

### **Art. 307      COMPETITION INVITATIONS & ENTRY FORMS**

307.1      Notification: After sanction by the IAU EC, notification of WCH, CCH, IC and CE (Art. 301) must be issued by the OC in writing at least six (6) months prior to the Competition. Such notification shall be sent to all member federations of the Field division (and any others as notified by the IAU EC), Members of the IAU EC and TC, Honorary Members, and shall include:

- a. Name of the Competition
- b. Place and date of the Competition
- c. Name and postal address of the OC
- d. Entry fees for Individuals
- e. Closing date for entries
- f. Preliminary accommodation arrangements, and
- g. Preliminary entry form for Cup Competition

307.2      Program: Two (2) months before the Competition, the final program must be sent to the federations taking part. The program must contain the following information:

- a. Detailed shooting program, including practice arrangements
- b. Time schedule for the Competition
- c. Provisional list of competitors' names
- d. List of awards and special prizes, and
- e. Agenda of any official meeting(s). The information specified under Art. 307.2 above must also be sent to all recipients of the original notification (Art. 307.1). All such information must be sent to the official contact persons as listed in the current IAU Address list (available from IAU Headquarters).

307.3      Entry Applications: The process of registration for IAU competitions is possible only online, no later than 2 weeks before the start of the competition. All the entry forms for participation in IAU events must be submitted through the IAU website. In





# IAU COMPETITION RULES

## FIELD CROSSBOW

order to generate an entry form, each country must have an administrator responsible for the data required for filling in the forms.

- 307.4 The final list of names of competitors in team and individual competitions must be given to the OC, in writing, not later than the evening before the Official Practice Day (Art. 320).

### Art.308

#### INTERNATIONAL COMPETITION, TITLES AND AWARDS

- 308.1 Team Competition: The team with the highest aggregate score of single IR 900 Round (IAU Classic Round) shot first day of Competition will be acclaimed:

At **WCH**: World Champion Team IAU Classic

At **CCH**: Continental Champion Team IAU Classic

- 308.1.1 The winner Team of Gold Medal Final duel in IAU Team Match Play Competition will be acclaimed:

At **WCH**: World Champion Team IAU Match Play

At **CCH**: Continental Champion Team IAU Match Play

- 308.2 Individual Competition: The competitors (Men, Women/Juniors, Cadets, Senior men, Senior women, Assisted Shooters) with the highest aggregate scores for IAU Classic round or any Indoor shot one single round will be acclaimed:

At **WCH**: World Champion IAU Classic (Man, Woman/Junior, Cadet, Senior man, Senior woman, Assisted shooter)

At **CCH**: Continental Champion IAU Classic (Man, Woman, Junior, Cadet, Senior man, Senior woman, Assisted shooter).

The winner of IAU Match Play Round will get the title IAU World (Continental) Champion IAU Match Play Man, Woman, Junior, Cadet, Senior man, Senior woman, Assisted shooter in discipline Field. (See Art. 350)

- 308.2.1 Junior and Cadet Competition: Competitors in the fewer than 18 age group shall be classed as Cadets. Competitors shall be eligible for such awards provided that they have NOT attained the age of 18 years on the first Competition Day. A federation may select





# IAU COMPETITION RULES

## FIELD CROSSBOW

competitors in the under 18 age group to compete in the Juniors, Men's or Women's divisions, but not in the Seniors division. These Competitors shall be classified in the selected Category in individual and Team.

308.2.2 Competitors in the fewer than 23 age group shall be classed as Juniors. Competitors shall be eligible for such awards provided that they have NOT attained the age of 23 years on the first Competition Day. A federation may select competitors in the fewer than 23 age group to compete in the Men's or Women's divisions, but not in the Cadets or Seniors divisions (Art. 308.2.2). All Cadets and Juniors must submit proof of age at time of Competition registration. There shall be no distinction between males and females.

308.2.3 **Senior Competition:**

Competitors having attained the age of fifty (50) on or before the first day of the Competition can be classed as Senior man or Senior woman. All Seniors must submit proof of age at the time of Competition registration.

308.2.4 **Assisted Shooters Competition:**

Competitors, they have such body disabilities, which do not enable them to shot without assistance the second person, can be classed as Assisted Shooters.

308.3 **Medals:** At WCH, CCH, WC and WCF the following awards shall be presented in accordance with Arts. 308.1, 308.2:

**Gold Medals:** Shall be awarded to the individual Man, Woman, Junior, Cadet, Senior man, Senior woman or Assisted Shooter and also for the Men's Team, Women's Team, Juniors Team, Cadets Team, 2 Seniors Teams or Assisted Team (Art. 303.2) achieving the highest score.

**Silver Medals:** Shall be awarded to the individual Man, Woman, Junior, Cadet, Senior man, Senior woman or Assisted Shooter and also for the Men's Team, Women's Team, Juniors Team, Cadets Team, 2 Seniors Teams or Assisted Shooters Team (Art. 303.2) achieving the second highest score.

**Bronze Medals:** Shall be awarded to the individual Man, Woman, Junior, Cadet, Senior man, Senior woman or Assisted Shooter and



# IAU COMPETITION RULES

## FIELD CROSSBOW

also for the Men's Team, Women's Team, Juniors Team, Cadets Team, 2 Seniors Teams or Assisted Shooters Team (Art. 303.2) achieving the third highest score.

- 308.4 Participation Awards: All Competitors and officials shall be presented with a Participation Award to signify their participation in a particular IAU sanctioned Competition. Such awards may bear the emblem of the IAU, host organization and/or Competition logo. The presentation of participation awards restricted to competitors, judges and IAU officials in attendance. Members of the OC, Scorers and field parties may also receive these awards at the discretion of the OC.
- 308.5 Individual WCH, CCH, WC and WCF medals shall be supplied by the IAU for all categories. The IAU EC will contribute 50% of the cost, the remaining 50% being paid by the OC.
- 308.6. World Cup Final Winner: Women and Men will receive a small IAU Crystal globe supplied by IAU. (Art. 360.8)
- 308.7. The cost of team awards, special prizes for the winners of each category and participation medals shall be borne by the OC.



# IAU COMPETITION RULES

## FIELD CROSSBOW

### **Art. 309**                    **INTERNATIONAL COMPETITION RESULTS**

- 309.1                    During WCH, CCH, WC and WCF, current lists of results shall be posted where they can be seen by the competitors and the spectators.
- 309.1.1                Before the Medal presentations, a full list of results shall be posted (Art. 336).
- 309.2                    At the end of the competitions a copy of the final results list checked and signed by IAU TC Field Chairman must be given to all officials and competitors as quickly as possible as but not later than the same day. The results list must cover both Team and Individual results together with details of distance scores (Art. 313.4).
- 309.3                    The organizer has to send the file of the results to the secretary general of the IAU. He has to publish the results daily on the IAU website.

### **Art. 310**                    **RECORDS**

- 310.1                    WORLD RECORDS (individual and team) may be established in all recognized IAU Men's, Women's, Junior, Cadets, Senior man, Senior woman and Assisted Shooters Categories in WCH, CCH, WC and WCF which have been conducted in accordance with these Rules.
- 310.2                    CONTINENTAL RECORDS can only be recognized if set at WCH, CCH, WC and WCF provided such events are conducted in accordance with these Rules.
- 310.3                    WORLD AND CONTINENTAL RECORDS will be recognized for the following rounds and distance scores:  
Team Records: IR 900 Round, 18 meters IR 600 round.  
Individual Records: IR 900 Round, Indoor 18-meter IR 600 Round.  
Single Distance Scores: 18m.
- 310.3.1                Records can only be established in the category in which the competitor is entered, i.e., a Junior competitor can only establish a Junior Record if he is shooting in the Junior category, even



# IAU COMPETITION RULES

## FIELD CROSSBOW

though he may have shot a score higher than the existing Men's, Women's, Cadets', Senior man or Senior woman record.

310.4 The scoring shall be conducted in strict compliance with Article 325 of these Rules.

310.5 World and Continental Records shall be maintained in a Register revised by the TC. Lists of Records should be distributed to member federations at reasonable intervals.

310.5.1 Claims for World Records: The athlete must submit a claim for a new World Record to the Chairman of the Field TC within one (1) month of the Competition.

Such claim(s) shall be supported by: original score sheet(s) duly signed on the day of the Competition by the athlete, the DOS and the chairperson of the OC; a copy of the official result list.

Subject to the above provisions being met and the receipt of a NEGATIVE Drug Test report on the athlete in question (where applicable), the TC Chairman will ratify the record and inform the athlete and the host federation to that effect, within one (1) month of receipt of the Drug testing result.

### **Art. 311 INTERNATIONAL JUDGES (IJ)**

Refer also to separate publication, "Judges' Guidelines".

311.1 The selection of two (2) International Judges (IJ) and a DOS (who shall also be an IJ) for WCH, CCH, IC or CE shall be the responsibility of the TC in conjunction with the OC. The IAU shall endorse all appointments. The IJs and DOS shall be selected from the TC list of approved IJ's.

311.1.1 At IC and CE at least one (1) IJ and a DOS, (who shall be an IJ), shall be appointed.

311.1.2 International Judges' Committee: The Chairman of the Field TC shall automatically be Chairman of the IJC at WCH, CCH, WC and WCF, or as otherwise delegated. Decisions made by the IJC/IJs shall be by simple majority and shall be binding on all parties, save for the provisions of Rights of Appeal contained in Art. 336 and Art. 337.

311.1.3 The OC is responsible for paying the costs of travelling and





# IAU COMPETITION RULES

## FIELD CROSSBOW

transportation and living expenses for IJ (accommodation) and catering).

- 311.1.4 Uniform: At WCH, CCH, WC and WCF, all IJs shall be dressed red /blouse/west (as determined by the TC from time to time), IAU will carry official accreditation issued by the TC.

**Duties:** The **IJ** shall perform the following functions:

- a. Check layout and dimensions of the shooting field as well as the suitability of all associated field equipment on the day prior to the first day of the Competition, and thereafter as necessary.
  - b. The Supervise is responsible to control the equipment of all Competitors on the day before the Competition commences for compliance with (Art. 326) and (Art. 327) and during the Competition as necessary.
  - c. Check the conduct of the shooting and scoring.
  - d. Consult with the DOS on questions which arise regarding the shooting, including the interruption of shooting due to weather conditions, a serious accident or other unforeseen occurrence, and ensure, if at all possible, that each day's program is completed on that day.
  - e. Process any major dispute or appeal which may arise, including determination of the scoring value of bolts lying at the intersection of two scoring zones.
  - f. Initial (in red ink) any corrections on score sheets.
  - g. The moving forward of the target butts, and check the correct relocation and alignment of the target butts on the appropriate target line (Art. 314.1.3).
  - h. Carry out the procedures outlined under Arts. 325 and 328 requiring the involvement of an IJ.
  - i. The Supervise and instruct Field Judges as necessary.
- 311.3 Director of Shooting (DOS): The DOS is responsible for the following duties:
- a. Regulating the timing of ends and controlling the shooting with a whistle or other suitable audible device, and controlling the



# IAU COMPETITION RULES

## FIELD CROSSBOW

actions of all competitors as defined in Art. 321.

- b. Controlling the regulation of the Visual Time Control Signals (VTCS).
- c. Instituting and enforcing whatever safety measures are considered necessary, exercising control over public address systems, the activity of photographers, the public and generally maintaining order.
- d. Ensuring the observance of the appropriate Time Limit for the shooting of an end of three (3) bolts and in cooperation with IJ's to ensure that all bolts have been drawn from the butts before shooting the next end.
- e. In liaison with the IJ, interrupt the shooting as necessary for reasons of safety or any other reason.
- f. One of the international judges should control the processing of the results of the competition.

### **Art. 312 FIELD JUDGES (FJ)**

Refer also to separate publication, "Judges' Guidelines".

- 312.1 The Field Judges (FJ) for WCH, CCH, IC and CE shall be selected by the OC from the TC list of approved FJs.
  - 312.1.1 FJs shall be appointed in the ratio of one (1) FJ for every twenty-four (24) competitors or part thereof. FJs shall be under the control of the IJC.
  - 312.1.2 Field Judges shall not participate in the shooting.
  - 312.1.3 At WCH, CCH, WC and WCF all Field Judges should preferably be dressed in grey lower garment with a red upper garment or tabard. Notwithstanding, all FJ should be similarly attired.
- 312.2. The Field Judges are responsible for the following duties:
  - a. The replacement of worn target faces or butt.
  - b. The supervision and timing for competitors who have made essential equipment repairs.
  - c. The settling of minor disputes and generally assisting the DOS.
  - d. The supervision of the moving forward of the target butts after the



# IAU COMPETITION RULES

## FIELD CROSSBOW

completion of each distance, and the correct relocation of the target butts on the appropriate Target Line under the supervision of the IJ.

- e. Initial any corrections on score sheets.

312.3. The list of International and Field referees is managed by the Secretary General of the IAU, in coordination with the presidents of the Field and Match Technical Committees.

### **Art. 313 OFFICIAL SCORERS, RESULTS AND SCOREBOARDS**

313.1 At WCH, CCH, WC and WCF sanctioned by the IAU, unless other provisions have been approved by the Field TC Chairman, independent Scorers can be appointed. One (1) scorer shall to be appointed for every four (4) competitors. Such Scorers shall be selected the OC and shall not participate in the shooting. If no scorers on WCH, CCH, WC and WCF sanctioned by the IAU, the shooters may do the scoring. The first Shooter from group of four Shooters is responsible scoring the first distance, the second the second distance and the third the third distance of the IR 900 Round.

313.2 The duties of the Scorers are as follows:

- a. Each Scorer shall be allocated four (4) adjacent targets (i.e., Competitors). Scoring shall commence with the left-most target of the allocation and proceed to the right.
- b. The Scorers shall carry out their duties under the supervision of the IJs. Any query or dispute over the scoring shall be referred to the IJC who will make the final decision.
- c. Scoring values shall be entered on the official Score Sheets in descending order of value for each bolt as called out by the competitor to whom the bolts belong. The other three (3) athletes within the Scorer's allocation shall check the value of each bolt called and also check that the corresponding entry has been entered on the appropriate Score Sheet.
- d. It is PROHIBITED for a Scorer to score the target of a relative.
- e. Scorer allocations shall be rotated after the completion of each distance.

313.3 Scoreboard: After each end, the progressive totals of at least the first eight (8) competitors in each division as Men, Women, Juniors,





# IAU COMPETITION RULES

## FIELD CROSSBOW

Cadets, Senior men, Senior women and Assisted Shooters shall be recorded on a large scoreboard (Art. 314.1.11) visible to the competitors and to the public.

313.4 At the completion of the day's shooting, the OC shall publish the score of each competitor for each of the distances as well as the final total achieved. At the end of the Competition the OC shall publish not only that day's results but the aggregate score of each competitor.

The OC shall also compute the result for each National Team. These results duly authenticated by the OC, shall be distributed to:

- a. Members of the IAU EC present
- b. International Judges
- c. The Director of Shooting
- d. Team Managers
- e. The Press

313.5 Independent Scorers shall:

- a. be under the control of a Chief Scorer. The Chief Scorer shall not take part in the actual scoring but shall be responsible for ensuring the conduct and operation of the Scorers.
- b. all is dressed in an official uniform, preferably white lower garment with a yellow-colored upper garment. Such clothing may bear sponsors' insignia, provided that the provisions of the IOC in regard to commercial advertising are adhered to.
- c. in keeping with the importance and spectacle of IAU sanctioned championships; march on and off the field at the commencement and cessation of scoring each end.

### **Art. 314 OUTDOOR FIELD LAYOUT**

314.1 At WCH, CCH, WC and WCF the size of the shooting field shall be determined by the number of competitors, i.e., the number of targets.

Note: Where shooting is restricted to the field area of a sports stadium the maximum number of targets (competitors) which can be accommodated is 120 for planning purposes.



# IAU COMPETITION RULES

## FIELD CROSSBOW

All competitors shall shoot on the same field (Men, Women, Juniors, Cadets, Senior man, Senior woman and Assisted Shooters) at targets placed at distances specified in (Art. 318.1).

314.1.1 The Range shall be squared-off and each distance accurately measured from a point vertically below the center of the “Gold” of each target to the Shooting Line. Distances shall be within  $\pm 10$  cm of the absolute distances specified in Art. 318.1.

314.1.2 Lines shall be marked on the field in whitewash or by means of white marking tapes as follows: Target Lines at each distance, a Shooting Line, a Waiting Line. Shooting lanes shall be marked at 90 degrees to the Shooting and Target Lines. Lanes shall be a minimum of 6 meters apart.

314.1.3 Target Butts shall be set up on the appropriate Target Line on stands at an angle of between 10 and 15 degrees to the vertical, provided that all stands are set at the same angle. The center of the 10-ring (“Gold”) shall be  $130 \text{ cm} \pm 5 \text{ cm}$  above the ground. Any portion of a butt which may damage bolt shall be covered.

**Layout A:** Where shooting takes place in one (1) relay on single butts (one target face) the minimum distance between the center of butts shall be minimum 1,25, optimum 1,50 meter i.e., maximum 4 single butts per shooting lane.

**Layout B:** Where shooting takes place in two (2) relays on double butts (two target faces) the minimum distance between the center of butts shall be 1,5 meters, i.e., maximum 4 double butts per shooting lane. Layout B may also be used for one (1) relay provided that only two (2) double butts be used to each six (6) meter lane.

Refer to Figure F1.

314.1.4 For the 35-meter distance the height of the two lower centers of each set of Three spot Faces (Art. 317.1.1) shall be  $121 \text{ cm} \pm 5 \text{ cm}$  above the ground.

314.1.5 Each target shall be numbered. Target Numbers (Art. 316.3) may be affixed above the center of each target face (but must be clear of the target face).





## IAU COMPETITION RULES FIELD CROSSBOW

- 314.1.6 Each butt shall carry a Wind Indicator Flag. The flags shall be placed 40 cm above either the center of the butt or the top of the target number board (as per Figure F1). Wind Indicator Flags shall be as specified Figure F4, the weight being approximately of 150 g/m<sup>2</sup>.
- 314.1.7 Points on the Shooting Line directly opposite the center of each butt shall be marked and numbered correspondingly.
- 314.1.8 At WCH, CCH, WC and WCF, VTCS shall be located on both sides of the Shooting Field (a third signal may be placed in the center of the field if necessary) in such a way that the VTCS can be seen by all the competitors on the Shooting Line. Signals (Art. 316.5) shall be placed in a clear lane (provided for the purpose) at a distance of 35 m in front of the Shooting Line.

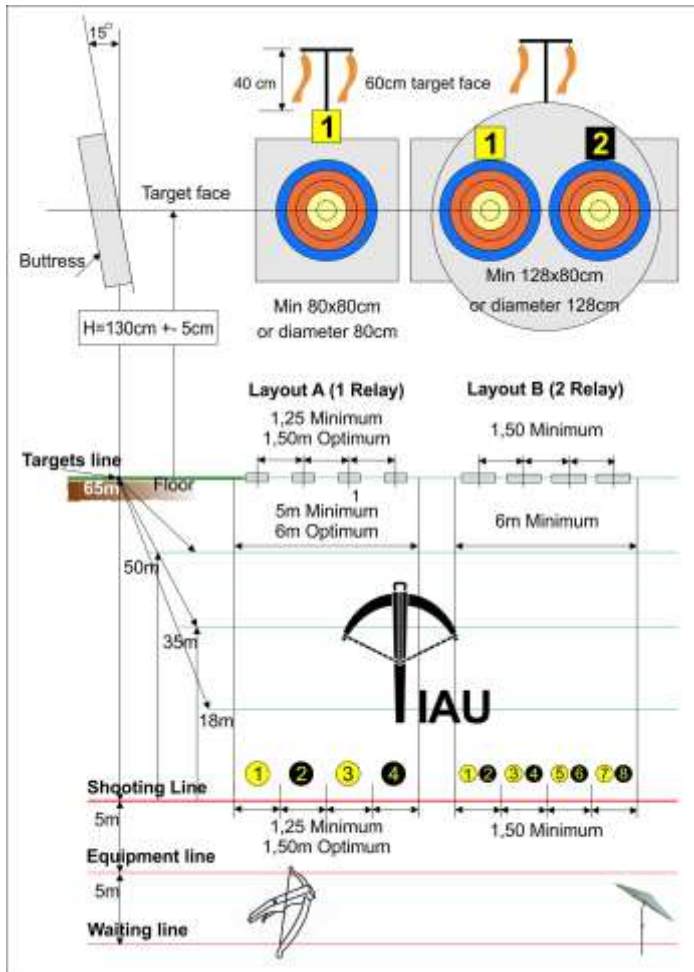

Figure F1: Field Layout (Refer to Art. 314)

314.1.9 At WCH, CCH, WC and WCF, the Shooting Line shall be fixed



# IAU COMPETITION RULES

## FIELD CROSSBOW

and buttresses shall be moved forward for each distance.

- 314.1.10 Suitable Barriers shall be erected around the field to keep spectators out of the danger area. Such barriers should be at least ten (10) meters behind the Waiting Line and at least sixty (60) meters beyond the Target Base Line. Barriers should be so placed as to prevent spectators from moving past a competitor's line of vision while on the Shooting Line. Barriers along the sides of the shooting area must be at least twenty (20) meters beyond the ends of the Target, Shooting and Waiting Lines.
- 314.1.11 At WCH, CCH, WC and WCF, a large Scoreboard (Leader Board) shall be placed so that it is visible both to competitors and spectators (Art. 313.3).
- 314.1.12 At WCH, CCH, WC and WCF seating, and if possible, appropriate shelter, shall be provided behind the waiting line for all competitors and officials.
- 314.1.13 An elevated chair or platform shall be provided for the DOS positioned between the Shooting and Waiting lines so that the DOS has an unobstructed view along the Shooting and Waiting Lines. This position should be, if possible, in the center of the Competition Field. Refer also to “**Guidelines for Organizers of World & Continental Championships**”.
- 314.2 WCH, CCH, WC, WCF, IC and CE Venue, Equipment and Facilities:
- 314.2.1 At all IAU sanctioned WCH, CCH, WC, WCF, IC and CE, the tournament grounds shall be clearly divided between:
- a. The Shooting Field
  - b. The Practice Field (if separate practice facilities are provided)
  - c. The Spectator and amenities area(s)
- The spectator area must be clearly defined by barriers.
- 314.2.2 WCH, CCH, WC, WCF, IC and CE, sanctioned by the IAU must take place on an open field, arena or stadium.
- 314.2.3 Adequate Toilet facilities for Men and Women respectively shall be provided within reasonable distance of the Shooting Field.
- 314.2.4 At WCH, CCH, WC and WCF, an area with seating accommodation and weather protection for the use of IAU



# IAU COMPETITION RULES

## FIELD CROSSBOW

Executives, Team Officials and Official Guests should be sited in a prominent position in the spectator area. In the vicinity of this main stand flag poles for the flag of the IAU and of the Host Federation shall be erected together with either enough flag poles for all competing countries, or a ground-mounted stand to display all national flags of the competing federations.

- 314.2.5 At WCH, CCH, WC, WCF, IC and CE the OC shall provide a Podium which is to be erected in front of the main stand for the awards ceremony. The central step shall be 60 cm high, and the other two steps 30 cm high. All steps shall be wide enough to accommodate all the members of each of the place-getting teams.
- 314.2.6 At WCH, CCH, WC and WCF the OC shall make two (2) rooms or adequate temporary shelter available to the IAU Executive, the IJ and FJ.
- 314.2.7 At WCH, CCH, WC and WCF, a public address system shall be available. It is recommended that IJ, FJ, and DOS be provided with suitable 2-way Radio Equipment to make communication more effective.
- 314.2.8 OC should provide a room with internet access for the press.
- 314.2.9 The OC must make available suitable doping control facilities, as may be required by the host nation's authorities.
- 314.3 The direction of shooting shall be within  $\pm 20$  degrees of North in the Northern Hemisphere and the reverse in the Southern hemisphere.

### Art.315 INDOOR LAYOUT

- 315.1 Three-Spot Target Faces: The use of three (3) separate target faces (i.e., one (1) shot per face) is permitted.
- 23,65 cm 3-spot full ring target faces must be used at the 18 meters indoor distance (see 315.1.1).
- Dimension "A" for 23,65 cm full 10 ring face = 236,5 mm
- Dimension "B" for 25 cm full 10 ring face = 225 mm
- 315.1.1 Butts may be set up at any angle between vertical and 10 degrees away from the direction of shooting. All butts must be similarly aligned.



- 315.2 Range markings are similar to the outdoor field layout (Art. 314.1.2). The waiting Line may if space does not permit be omitted.
- 315.3 In all other respects these Rules shall apply.
- 315.4 Illumination of Target Faces: whether natural or artificial, its effect on the target faces is important. Every effort should be made to minimize bolt shadows.
- 315.5 The distances from the floor to the bottom two 10-ring (“Gold”) centers of each three-spot face shall be  $121 \pm 5$  cm. See next page.



Figure F2: Field Layout (Refer to Art. 315):  
Indoor 18 m: 23,65 cm full ring 3-spot Target Face

<b>Ring Ø</b>	<b>Pantone Colour</b>
10 = 11,5 mm Ø	Pantone Yellow 107
9 = 36,5mm Ø	Pantone Yellow 107
8 = 61,5 mm Ø	Pantone Red 032
7 = 86,5 mm Ø	Pantone Red 032
6 = 111,5 mm Ø	Pantone Blue 306
5 = 136,5 mm Ø	Pantone Blue 306
4 = 161,5 mm Ø	black
3 = 186,5 mm Ø	black
2 = 211,5 mm Ø	white
1 = 236,5 mm Ø	white

315.6 Safety Precautions: Safety precautions behind the targets call for special attention i.e., the provision of special backstop netting.



Figure F3: 60 cm Target Face for Outdoor 65 m / 50 m / Final 50 m

<b>Ring diameter</b>	<b>Pantone Colour</b>
10 = 60 mm Ø	Pantone Yellow 107
9 = 120 mm Ø	Pantone Yellow 107
8 = 180 mm Ø	Pantone Red 032



# IAU COMPETITION RULES

## FIELD CROSSBOW

7 = 240 mm Ø	Pantone Red 032
6 = 300 mm Ø	Pantone Blue 306
5 = 360 mm Ø	Pantone Blue 306
4 = 420 mm Ø	black
3 = 480 mm Ø	black
2 = 540 mm Ø	white
1 = 600 mm Ø	white

### **Art. 316 FIELD EQUIPMENT SPECIFICATIONS**

- 316.1 Target Butts: Shall be so designed as to effectively stop bolts without pass-through and without causing undue damage to bolts.
- 316.1.1 Outdoor Butts: May be either round or square with a side length or diameter between 80 and 128 cm.
- 316.1.2 Indoor Butts: May be either round or square with a side length or diameter between 80 and 128cm, or a continuous wall of appropriate material.
- 316.2 Butt Stands: shall be so designed as to ensure that the center of the butt is 130 cm ( $\pm 5$  cm) from the ground and be capable of supporting the butt at an angle of between 10 and 15 degrees from the vertical.
- 316.2.1 Stands shall be securely pegged-down with butts being secured to the stands so as not to be blown over by wind gusts.
- 316.3 Butt (Target) Numbers: Shall be 30 cm square and shall be black on a yellow background alternating with yellow figures on a black background (e.g., N° 1 black on yellow, N° 2 yellow on black). Numbers shall be affixed in accordance with Art. 314.1.5. A point on the shooting line directly opposite each butt shall be marked and numbered corresponding to that butt. Such points shall be located in the ground 2 meters in front of the shooting line facing the competitors. For indoor competitions these numbers will be placed 1 meter in front of the competitor and taped to the floor.
- 316.4 Wind Indicator Flags: shall be made from any light-colored material (such as yellow) which contrasts with the general background behind butts, and shall be suspended from a 'T'-Pole

placed over the center of each outdoor butt in accordance with (Art. 314.1.6). The dimensions of such wind indicator flags shall be specified in Figure F4, the weigh being approximately 150 g/m<sup>2</sup>.

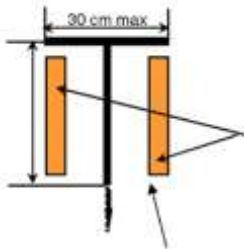

Wind Flags (2)  
40 cm x 5 cm (+/- 1 cm)  
  
Weight  $\approx$  150 g/m<sup>2</sup>  
  
40 cm (max) above Butters

Figure F4: Wind Indicator Flag Specification (Refer to Art. 316.4)

- 316.5 Visual Time Control System (VTCS): At WCH. CCH. IC and CE one of the following visual time control systems shall be employed.
- 316.5.1 Time Control Plates: The plates should not be less than 120 cm by 60 cm in size. They must be securely mounted to resist any wind and must be easy to turn quickly to show either side. One side of the plate shall be striped with 20-20 cm wide stripes, alternative in black and yellow. The strips shall be at an angle of about 45 degrees to the ground. The reverse side shall be solid yellow.
- 316.5.2 Time Control Lights: The colors shall be RED, AMBER (YELLOW) and GREEN in that order with RED the uppermost color. Lights located on the shooting field must be synchronized and at no time shall two (2) different colors be shown at the same time. Lights may be linked with an acoustic signal (whistle, siren or hotter) to operate electronically, but also must be able to be manually overridden as and when the need arises. Back-up manual time control devices (plates) as per Art. 316.5.1 shall also be available in case of electrical power failure or malfunction. Refer Art. 321.2.2 for signal hierarchy.
- 316.5.3 Clock Control: Digital clocks shall have figures (displays) not smaller than 30 cm in height and must be readable from a distance of 180 meters. They must incorporate facilities to be stopped and reset and shall operate on the count-down principle. Alternatively,



# IAU COMPETITION RULES

## FIELD CROSSBOW

analogue clocks may be used with circular and a single clockwise moving hand. The faces shall be painted with Red, Green and Amber colored sectors. The time for the clock to describe one full revolution shall be three (3) minutes and twenty (20) seconds, with each color being swept for the following times:

<b>RED</b>	20 seconds
<b>GREEN</b>	2minutes 30 seconds
<b>AMBER</b>	30 seconds

The junction of the RED and GREEN shall be at the 12 o'clock position. The clock shall be clearly readable from a distance of 180 meters. Back-up manual time control plates shall be available in case of clock failure.

- 316.5.4 Time Control Devices shall be set out in accordance with (Art. 314.1.8).
- 316.5.5 In the event of a difference between the visual signal and the audible, the AUDIBLE signal shall take precedence. Refer to SAFETY (Art. 332.3).
- 316.6 Miscellaneous Equipment: The following equipment is mandatory at all IAU sanctioned WCH, CCH, WC, WCF, IC and CE; and recommended in relation to importance of other competitions.
- 316.6.1 A-B Boards: Where shooting takes place in two (2) relays, a device to indicate the order of shooting: A-B; B-A; A-B, etc. The letters shall be large enough to be read by all competitors from their shooting positions. Two or more such devices may be needed. The background size shall be no less than 60 cm x 60 cm and the letters shall be no less than 40 cm high with alternating colors black and yellow, i.e., the "A" should be yellow on black and the "B" should be black on yellow.
- 316.6.2 Signal Flags: Red colored hand flags shall be provided for each target such that competitors at the target and competitors at the shooting line can signal for a Judge in the event of a dispute or equipment failure, respectively. Two (2) such flags shall be provided per target. The flags should be at least 40 cm long x 25 cm high, secured to a suitable handle.
- 316.6.3 Field Equipment Specifications for IAU Match Play Round: Refer to Competition Rules for IAU Match Play Round - Art. 350.





# IAU COMPETITION RULES

## FIELD CROSSBOW

### **Art. 317 TARGET FACES**

317.1

There shall be four (4) sizes of circular Target Faces for International Target Crossbow shooting as follows:

Outdoor competitions: 60 cm diameter full ring and 40 cm reduced 3-spot.

Indoor Competition: 23,65 cm full ring or 40 cm reduced 3-spot.

These faces are divided into five (5) concentric color zones from the center outwards as follows: GOLD (Yellow), RED, LIGHT BLUE, BLACK and WHITE. Each color in turn is divided by a thin line into two (2) zones of equal width thus making ten (10) scoring zones of equal width, measured from center of the Gold. The width of each scoring zone shall be as follows:

3 cm wide on the 60 cm target face (center 6 cm),

2 cm wide on the 40 cm target face (center 4 cm), and

1, 25 cm wide on the 23,65 cm target face (center 1,15 cm)

The exact center of the face is termed the “pin-hole” and shall be indicated with a small cross (+), the lines of which shall be no larger than 2mm.

317.1.1

At WCH, CCH, IC and CE recognized by the IAU, 40 cm 3-spot reduced faces must be used at the 35m distance. Such faces shall have the 5 to 1 lower scoring rings removed. The lowest scoring zone is therefore 6 and it is black. Each “set” consists of three small faces on a white background arranged symmetrically in a triangular pattern (see Figure F5). The centers of the two lower faces shall be 210 mm distant from each other, and the center of higher faces is 190 mm higher than the line of two lower faces. The distance from the ground to the centers of the lower pair of faces shall be 121 cm ( $\pm 5$  cm).

At Indoor WCH and CH three (3) spot faces must be used at

18 m the center of the two lower faces shall be  $121 \pm 5$  cm from the floor (see Art. 315.1).

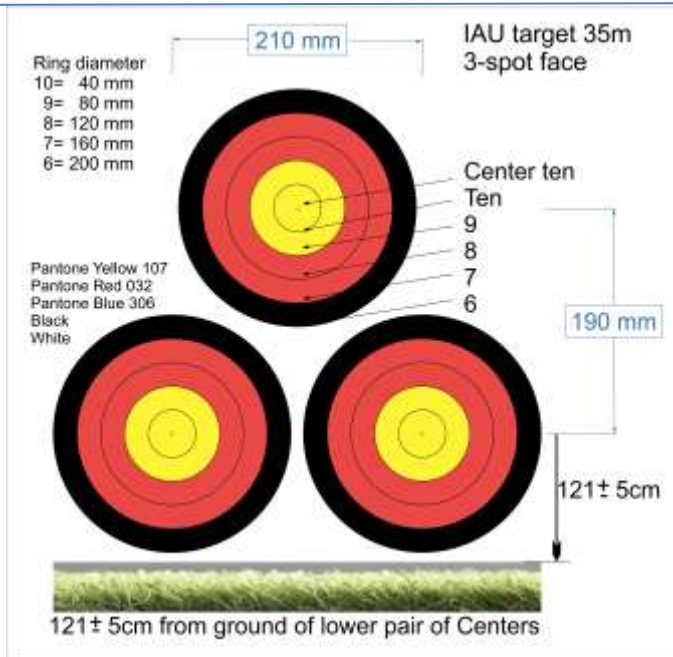

Figure F5: 40 cm 3-Spot Target Faces

317.1.2 Tolerance (scoring zone diameters):

60cm target face ± 1 mm

40 cm target face ± 1 mm

23,65 cm target face ± 0.5 mm

Measured over the outside of the dividing line between zones.

317.1.3 Zone dividing lines shall not exceed 2 mm in width and shall lie entirely within the higher scoring zones.

317.1.4 Target Face color Specifications shall be in accordance with the following Munsell color notations:

Yellow Pantone Yellow 107

Red Pantone Red 032

Blue Pantone Blue 306



# IAU COMPETITION RULES

## FIELD CROSSBOW

317. 1.5 Target Face Material: Target faces shall be made from non-reflecting paper, reinforced to prevent premature tearing. All faces shall be uniform and made from the same material. Printing shall be non-reflecting.

At WCH, CCH, WC and WCF all faces must be from the company Krueger. This company has the exclusive rights to produce the faces with the name of the IAU.

317. 2 Scoring Values for:

Yellow	Inner zone 10, outer zone 9
Red	Inner zone 8, outer zone 7
Light blue	Inner zone 6, outer zone 5
Black	Inner zone 4, outer zone 3
White	Inner zone 2, outer zone 1

317. 3 Official Faces: Only those target faces as licensed for use by the IAU shall be used. According to the Contract, the IAU only uses the Krueger Schießscheiben targets.

### **Art. 318 INTERNATIONAL TARGET ROUNDS**

318.1 On WCH, CCH, IC and CE sanctioned by the IAU, only the outdoor IAU Classic Round shall be shot. Round IAU Classic shall be shot first day of Competition for three distances: 65m, 50m, 35 m and IAU Match Play shall be shot on second and third day in accordance with article 350.

318.1.1 Round IAU Classic shall be shot on distance 65m, 50m and 35m this way:

Day begins on distance 65m, then on 50m and ends on 35m. The 65 m and 50m shall be shot on 60 cm diameter target face and 35m is using three spot reduced target face 40 cm. The results of the first day (all three distances) determine Team Results (Art. 303.2).

Two (2) ends of three (3) sighter bolts are permitted at the commencement of all distances (i.e., the 65m distance, 50 m distance and 35 m distance) in 5 minutes. Such sighter ends shall not be scored. Sighters shall be shot in accordance with (Art. 323).

Results of IAU Classic determine the qualification for IAU Match





# IAU COMPETITION RULES

## FIELD CROSSBOW

Play finale of individuals according to article 350.

Second day WCH, CCH, IC and EC shall be shot IAU Match Play rounds including semi-finals and on the third day Medal Matches of IAU Match Play round.

318.2.1 Indoor IR 600 round shall consist of 60 Bolts at 18m using 23,65 cm Face. Highest possible score are 600 points.

Two (2) ends of three (3) sighter bolts are permitted at the commencement of the Competition in 3 minutes; such sighter ends shall not be scored.

Sighters shall be shot in accordance with (Art. 323).

318.4 Indoor Rounds:

The following indoor rounds may be used for the purposes of IAU sanctioned Indoor Competitions (Art. 301.5).

Note: Such mail scores shall not be recognized as WCH or CCH Records.

318.4.1 IAU 18 m 600 Rounds:

60 Competition bolts from 18m using 23,65 cm full range face.

Possible score 600 points. The scoring for all indoor distances is according the Art. 318.4.4. Three (3) bolts shall be shot per end. At the beginning of a round, two (2) ends of three (3) sighter bolts shall be permitted in three minutes. Such sighter bolts shall not be scored, but recorded.

### **Art. 319 TARGET ASSIGNMENT AND COMPETITOR NUMBERS**

319. 1 Target Numbers: At WCH, CCH, IC and CE sanctioned by the IAU, the assignment of Target Numbers shall be the responsibility of the OC. One athlete shall be assigned to each target face.

319.2 First Round Seeding:

The random allocation of competitors to shooting line must be done under the supervision of the Chairman of the IAU Technical Committee with a computer program designed for this purpose or by the drawing of lots.



# IAU COMPETITION RULES

## FIELD CROSSBOW

Individual competitors and teams (nations) should be able to shoot under conditions that are as near as equal as possible;

Competitors from the same nation should not be allocated adjacent on the Shooting line.

- 319.2.1 The Shooting line is covered in order by Men, followed by Women, Assisted Shooters, Juniors, Cadets, Senior men, Senior woman, Guests. Within these groups, there will be a draw for the order of teams, then the competitors from teams will be positioned according to the following principle: 1-a1, 2-b1, 3-c1, 4-d1, 5-e1, ... 6-a2, 7-b2, 8-c2, 9-d2, 10-e2, ... 11-a3, 12-b3, 13-c3, 14-d3, 15-e3 (example for 5 teams; a- first member of the team, b- second member of the team, c- third member of the team), and there will be another draw for the remaining firing positions among the remaining competitors from the individual competition.

The Chairman of Technical Committee will prepare for Team leaders meeting three different Start lists prepared on this way and there will be draw one list for a competition.

- 319.2.2 The assignment of Guest Competitors (Art. 304.3) shall take place only after all competitors from Member Federation have received target allocations i.e., Guest Competitors shall be assigned to the remaining targets.

- 319.3 The OC shall notify in writing members of the IAU Executive present, IJs, FJs, the DOS and NTMs, the target allocations immediately after the draw has been completed. Any individual competitor not represented by a NTM will be notified of their target allocation, in person, by the OC. A list of target allocations shall be placed on display by the OC, for the spectators and members of the Press.

- 319.3.1 Official Communication: The OC shall provide suitable labelled pigeon holes or trays, one for each IAU official, IJ and participating federation. These shall be located within easy access of the shooting field.

- 319.4 Competitor Numbers: The OC shall issue all competitors with Competitor numbers, such that they may be visible from a distance of at least 50 meters. Minimum size shall be DIN A4 ( 297x210 mm ) with numbers at least 150 mm high. Such competitor numbers may carry sponsor logos. Refer to Art. 330.4





# IAU COMPETITION RULES

## FIELD CROSSBOW

And Art. 330.6.

- 319.4.1 Athlete shall wear their Competitor Number on the middle of the back, in such a manner as to be visible at all times while shooting is in progress (Art. 330.4).
- 319.6 Equal Shooting Conditions: Shooting conditions in terms of the condition of the ground surface, visual distraction, noise, climatic condition, light, etc. shall be uniform for all competitors, as far as is reasonably possible.
- 319.6.1 For outdoor competition in case that the ground on shooting line needs an adjustment for standing position, it shall be adjusted but no holes or footprints by using hammer, shovel or other equipment are accepted.
- 319.6.2 For indoor competition, in case of slippery ground, the organizer must give a carpet or a piece of carpet for every competitor.
- 319.6.3 It is not permitted to put any substance under the sole or on the floor of the shooting post to gain an unfair advantage, or to wipe the shooting range without permission.
- 319.6.4 The use of any special devices, including the use of elastic bandages, medical taping and studs increasing artificially the performance is forbidden.
- 319.6.5 It is not permitted to place non-removable tape or draw lines with permanent marker on the floor.

### **Art. 320 PRACTICE**

- 320.1 Use of Competition Field: At WCH, CCH, IC and CE sanctioned by the IAU; the Competition field may be used by the competitors for practice prior to the days of the Competition in accordance with the times announced in the Program (Art. 307.2).
- Where the Competition field is not available for practice, the OC shall provide suitable facilities as detailed in Art. 314.2.1.
- 320.1.1 Practice Field: At WCH, CCH, WC and WCF, the OC shall make practice facilities available at least two (2) days before the Official Practice Day. Such practice facilities, if possible, shall be the Competition field, or be located on a separate field adjacent to the main Competition field.



# IAU COMPETITION RULES

## FIELD CROSSBOW

A number of targets equal to two thirds the number of confirmed entries should set out on the Practice Field. Such practice facilities are to be announced in the Program (Art. 307.2).

320.1.2 Practice Field Captain (FC): Shall at all times be in charge of practice sessions. The FC shall be solely responsible for the conduct of shooting.

It is suggested that a fixed period of time (e.g., 5 minutes) be allocated for shooting and that there shall be no limit to the number of bolts which can be shot within this time limit.

320.1.3 Control of Practice: All competitors shall move forward together to collect their bolts, irrespective of the distance being shot. No athlete shall shoot during this time, nor collect bolts at any other time.

The FC may bar from the practice session any athlete contravening this rule.

320.1.4 Allocation of Butts for Unofficial Practice: On Unofficial Practice days, the butts shall be set out at distances of 65, 50 and 35m in proportion according to the direction of the FC. Competitors desirous of changing the butt allocation shall negotiate with the FC. Any Change in the distance at which targets are set shall be regulated by the FC, who may ask practicing athlete to assist in moving and re-arranging targets.

320.2 Conduct of Official Practice: Official Practice shall take place on the tournament field in accordance with the details set out in the Program (Art. 307.2). In that the regulation of ends (visual time control) under the control of the DOS shall be employed. Members of the IJC shall be present to observe the conduct of the shooting and, in liaison with the NTMs, advice competitors over matters of procedure. The OC shall arrange for a sufficient number of FJs (Art. 312.2.c) to be in attendance to assist the DOS in the running of the practice session.

Official Practice Butt Allocation: each competitor shall use target assigned to him/her for the Competition (Art. 319.2.2).

320.2. 1 Official Practice Day Field Layout: All butts shall be set at 35m to begin Official Practice, then moved to 50m, and finishing the session at 65m for all athletes.



# IAU COMPETITION RULES

## FIELD CROSSBOW

320.2.2 Official Practice Timetable: To timetable shall be submitted to the IJC for approval no later than twenty-four (24) hours before the start of Official Practice:

Recommended timings:

09:00 -10:30 35m practice

11:00 -12:30 50m practice

12:30-13: 30 Lunch break

13:30 -15:00 65m practice

Practice (shooting) on the tournament field or the practice field between the official start and finish times on the days of competition is NOT PERMITTED.

320.3.1 Test Butt: For the purpose of testing a crossbow which has undergone essential repairs, a target butt shall be set out at a maximum distance of 20m in an area separated from the tournament field. The use of such facilities shall be under the supervision of a TC Member or Judge.

320.4 Practice of the Shooting Stance: On days of Competition before the Competition starts and during the intervals between distances, competitors may practice only the shooting position and sighting, without cocking/spanning/loading their crossbows. Such practice may only take place on the shooting line and in the direction of the competitor's allocated target.

NO AIMING "Dry – Firing" exercises are permitted if personnel are in front of the Shooting Line (Art. 332.1.1).

In the event that a bolt is shot during such practice, the bolt shall count towards the next scoring end shot. The scorer shall make a note to this effect on the score sheet; the highest scoring bolt for the next scoring end shall be forfeited. The athlete concerned shall be cautioned by a Judge. An athlete repeating this offence may be barred from the day's Competition. See (Art. 335.2).

### Art. 321 TIME CONTROL AND SIGNALS

321.1 Athletes shall shoot their bolts in ends of three (3) shots under the control of the DOS. The order of shooting shall be as follows:





# IAU COMPETITION RULES

## FIELD CROSSBOW

- 321.1.1 One Relay: When shooting takes place in one (1) relay, all athletes shall go to the shooting line together.
- 321.1.2 Two Relays: When shooting takes place in two (2) relays, athletes shall shoot one at a time on each target as follows:  
During Sighters: A-B, A-B  
Competition shots: A - B, B - A, A - B, etc.
- 321.1.3 Designation of A-s and B-s: Those competitors shooting on odd numbered targets shall be the “As” and those shooting on even numbered targets shall be the “Bs”, when shooting is conducted in two (2) relays.
- 321.2 Timing Sequence (Competition Shots): The timing of ends shall be regulated as follows:
- Three (3) minutes shall be the Time Limit allowed for an athlete to shoot an end of three (3) scoring bolts.
  - The acoustic signals (Art. 321.3) shall be supplemented by a visual warning 30 seconds before the expiry of the three (3) minute period.
  - Twenty (20) seconds shall be allowed for the athletes to take their position on the line prior to the commencement of shooting.
- Time Limit for Indoor Competition:
- Two (2) minutes shall be the Time Limit allowed for an athlete to shoot an end of three (3) scoring bolts.
  - Three (3) minutes shall be the Time limit allowed for an athlete to shoot an end of four (4) scoring bolts. Refer Art. 321.2.2.
- 321.2.1 Timing Sequence (Sighting Shots): The timing sequence shall be extended to allow the competitors five (5) minutes to shoot two ends of three (3) sighting shots at the commencement of each Competition distance (Art. 323). Refer to Final Rules Art. 350.
- 321.2.2 Control of Time Limits: The acoustic signals shall take priority over visual signals in the control of time limits.  
Refer to SAFETY (Art. 332.3).
- Note: The reason for giving the acoustic signals precedence is for safety reason, particularly since not all shooters can see the visual



# IAU COMPETITION RULES

## FIELD CROSSBOW

- signals when sighting. Athlete with hearing deficiency can be warned by local people in the event of an emergency.
- 321.2.3 End Re-Start Time (Single Relay): Where shooting takes place in one (1) relay, the DOS shall allow a minimum of 40 seconds to elapse from the time the last competitor has retired behind the shooting line after the collection of bolts, prior to re-starting the timing sequence (Art. 321.2).
- 321.2.4 Illegal Shots: The maximum time permitted for an athlete to shoot an end of three bolts shall be three minutes (except during sighter ends - Art. 323). Any athlete shooting a bolt before the signal or after time signal denoting such time limits, shall forfeit the highest scoring bolt of the first scoring end.
- The athlete concerned shall be cautioned by an IJ. An athlete repeating this offence may be barred from the day's Competition. Refer Art. 335.2.
- 321.3 Acoustic Control Signals: The following Acoustic Control Signals (whistle or other suitable audible device) shall be used in conjunction with one of the visual systems outlined in (Art. 321.4).
- The following acoustic signals ca. two (2) seconds) shall be used:
- Two sound signals: Calls designated athletes to the shooting line.
  - One sound signal: For athletes to commence shooting.
  - Two sound signals: For athletes to cease shooting and Change relays.
  - Three sound signals: Move forward, score and collect bolts.
- Short sound signal (maximum one (1) second): End of shooting.
- A series of sound signals, four (4) or more, indicates Danger – all shooting must cease immediately.
  - The signal to resume shooting shall be ONE (1) sound signal.
- 321.4 Visual Time Control Systems (VTCS): At WCH, CCH, IC or CE sanctioned by the IAU, the acoustic signals shall be supplemented by one or more of the following VTCS (Art. 316.5):



# IAU COMPETITION RULES

## FIELD CROSSBOW

- a. Time control lights
  - b. Time control plates
  - c. Clock control
- 321.5 Time Control Plates: When shooting is controlled by plates the yellow and black striped side shall be turned towards the athletes as a signal of Warning that only 30 seconds of the three (3) minute time limit remains. The solid yellow side of the plates shall be turned towards the athletes at all other times.
- 321.6 Time Control Lights: When shooting is controlled by lights: the following signal sequence shall be followed:
- a. With red indicated, the DOS shall sound two (2) acoustic signals to summon the designated competitors to the Shooting Line.
  - b. Twenty (20) seconds later the lights shall be changed to green and one (1) acoustic signal given for the shooting to commence.
  - c. After two and a half (2 ½) minutes, the lights shall be changed to amber (yellow), warning competitors that they are within the last thirty (30) seconds of the time allowed for an end of three (3) bolts.
  - d. After three (3) minutes, the lights shall indicate red and two (2) or three (3) acoustic Signals given to end Shooting, as appropriate.
- 321.7 Clock Control: When timing is controlled by clocks, the procedure is the same as required for lights, as per Art. 321.6.
- 321.8 Whenever the Shooting Line is vacated by the athletes having shot their three bolts before the 3-minute time limit has expired, the appropriate signal to Change relays or advance for scoring shall be given.
- 321.8.1 After an athlete has shot his third bolt (of an end) he shall leave the shooting line. It is permitted to spot each bolt.
- 321.9 If shooting is suspended during an end for any reason, the time limit shall be adjusted to compensate for the time lost.
- 321.10 Time Interval between Distances: At WCH, CCH, IC or CE sanctioned by the IAU, the interval between shooting one distance



# IAU COMPETITION RULES

## FIELD CROSSBOW

and the commencement of the next must not be less than THIRTY (30) minutes and must not exceed ONE (1) hour.

### **Art. 322 SHOOTING POSITION**

322.1 Stance: An athlete shall shoot from the **STANDING POSITION** and without support with one foot on each side of the shooting line. The position of the feet may be marked on the ground only by means of one (1) marker for each foot. These markers shall not be more than 20 mm in diameter and shall not protrude more than 5 mm above the ground.

322.1.1 Athlete with Disabilities: In the case of an athlete who through permanent disability must use a wheelchair, the wheelchair, shall be centered over the shooting line. The crossbow must be held with the arms only. Assisted wheelchair competitors may use an IAU approved Support Stand, in accordance with Art. 322.2. The elbow of the supporting arm is not to make contact with the lap, wheelchair or gain support other than from the rib cage or abdomen. The backrest of the wheelchair shall not be higher

than 10 cm below the athlete armpits in the shooting position. Athlete with a foot or feet must place them on the footrests of the wheelchair when shooting.

322.2 No part of the body or clothing shall make contact with any other object. No part of the crossbow nor attachment shall touch the ground (nor floor) when being shot.

322.2.1 Butt hooks (Art. 326.2.3) may NOT be placed between the body and the shooting clothing, nor may the butt hook lie on top of the shoulder.

322.3 Spanning and Loading Position: The athletes may adjust its foot position in relation to the shooting line in order to span its crossbow.

322.3.1 It is not permitted to shot without shoes (with or without socks).  
The act of placing a bolt must be performed with the crossbow directed at the ground (or floor) immediately in front of the shooting line in the direction of the athletes' allocated target butt.

322.3.2 Elevated Crossbows: Placing a bolt in an elevated crossbow is NOT PERMITTED.





# IAU COMPETITION RULES

## FIELD CROSSBOW

An athlete who fails to observe this SAFETY RULE may be DISQUALIFIED.

The athlete concerned shall be cautioned by an IJ.

An athlete repeating this offence shall be DISQUALIFIED from the Competition (Art. 335.2).

### **Art. 323 SIGHTING SHOTS**

323.1 The following sighting shots are allowed at the start of each Competition (formerly found/distance). Such sighting shots shall be under the control of the DOS and shall be remark in scoring list but shall be not scored:

a. IR 900 Round:

- 65m: Two (2) ends of three (3) shots, five (5) minutes per end
- 50m: Two (2) ends of three (3) shots, five (5) minutes per end
- 35m: Two (2) ends of three (3) shots, five (5) minutes per end

b. Indoor Competitions: Where indoor rounds are shot in sessions e.g., 2 x 30 shots with halt interval of more than sixty (60) minutes between sessions, then one (1) end of Sighters shall be shot at the start of each session.

18m: Two (2) ends of three (3) shots, three (3) minutes per end.

323.2 Additional Sighting Shots for Prod Breakage: THREE (3) additional sighter Shots shall be allowed in the event of Prod BREAKAGE during a Competition round, including breakage's occurring during sighter ends (Art. 323.1).

The athlete shall adopt the Equipment Failure procedure (Art. 328). Such sighter shots shall be taken under the supervision of a Judge, prior to making up the end(s) not shot.

The time allowed for the Competition of the Three (3) Sighting shots shall be three (3) minutes (or two (2) minutes for 18m round). The bolts shall not be scored.



# IAU COMPETITION RULES

## FIELD CROSSBOW

---

### Art. 324 COMPETITION SHOTS

324. 1 Shooting cycle: At WCH, CCH, IC and CE sanctioned by the IAU, athletes shall shoot their bolts in ends of three (3) bolts each. All shooting shall be controlled by the DOS. Scoring shall take place after the completion of each end. Having shot his/her end of three (3) bolts, the athlete shall immediately retire behind the Waiting Line (Art. 321.8.1). An athlete remaining on the shooting line having completed the shooting of an end, shall be cautioned by an IJ (Art. 321.8). An athlete repeating this offence may be barred from the day's Competition (Art. 335.2).
- 324.1.1 3-Spot Faces: When using the 3-Spot 40cm Target Face, athlete shall shoot one (1) bolt per target face, in any order (see Arts. 325.5.1 and 325.8).
- 324.2 Repair Time: Should it be necessary to change a bowstring or make essential adjustments or repairs, an FJ/IJ must be advised (Art. 328).
- Reasonable time shall be allowed to make repairs, as determined by an IJ (Art. 328.2.2 and 328.3).
- Only a broken string in separate pieces is accepted as an equipment failure. In the case of a damaged bowstring (i.e., a broken strand, adorn serving thread), the bowstring may be replaced but without the right for sighters or an extra shot. The shooter will get 1 minute additional time.
- 324.3 Bolts which can be re-shot: A bolt shall not be deemed to have been shot if:
- The athlete can touch the bolt with his crossbow without moving his/her feet from their position in relation to the Shooting Line.
  - The target butt blows over (in spite of being pegged down to the satisfaction of the IJ – Art. 316.2.1). The IJ/DOS shall take whatever measures they deem necessary and then allow the appropriate time limit for shots remaining.
- 324.4 A shot made without a bolt in the crossbow may be re-taken correctly but no extra time shall be allowed. An athlete repeating





# IAU COMPETITION RULES

## FIELD CROSSBOW

---

the error will be cautioned by a Judge.

An athlete repeating this offence may be barred from the day's Competition. (See Art. 335.2).

324.5 Bolts in a Wrong Target: See Art. 325.8.

324.6 Leaving the Shooting line: An athlete is not permitted to leave the Shooting Line (unless having completed the shooting of the end) without first advising a Judge in accordance with the Equipment Failure provisions (Art. 328), even if there has not been a legitimate equipment failure.

An athlete repeating the error will be cautioned by an FJ/JJ.

An athlete repeating this offence may be barred from the day's Competition. (See Art. 335.2).

324.6.1 Spare Bolts: athletes shall take spare bolts with them to the shooting line.

324.7 Rebounds and Hangers: See Art. 325.9.1 and Art. 325.9.4.

324.8 Safety: All shooting shall be controlled in accordance with the safety provisions (Art. 332) of these Rules.



# IAU COMPETITION RULES

## FIELD CROSSBOW

### Art. 325 SCORING

325. 1 Frequency: At WCH, CCH, IC and CE sanctioned by the IAU, scoring shall take place after each end of three (3) sighting and competition shots. The DOS shall give the signal (Art. 321.3) to advance to the targets for scoring and retrieval of bolts.
- 325.1.1 Any bolt missing the target MUST immediately be declared by the competitor so that steps can be taken to locate and remove the bolt from the ground.
- 325.2 Order: The order in which scores shall be recorded on the score sheet is defined in Art. 313.2.c.
- 325.3 Touching the Target Face, Bolts and Butts: Neither the bolts, target face nor butt shall be touched until all the bolts within a scorer's allocation have been recorded.
- 325.4 Bolt Position in Target: A bolt shall be scored according to the position of the shaft on the target face where it lies.
- 325.4.1 A 'Robin Hood' shot shall be scored according to the position of the shaft in which it is stuck.
- 325.5 Excess Bolts in Target: If more than three (3) bolts are found belonging to the same athlete in the same target face, butt (or stand) or on the ground in the shooting lanes, only the three (3) lowest in values shall be scored.
- 325.5.1 When using the 3-spot 40 cm target face at 35m or 18m:  
If an athlete shoots more than one bolt into a face, then only the HIGHEST bolt in that face shall score. The value of the smaller arrow is evaluated as zero.  
A bolt outside the scoring rings of the own target counts as a miss (zero).
- 325.6.1 Center Tens: Bolts entirely within the Ten (10) zone and not touching the dividing line shall be entered on the score sheet and the entry circled to indicate a "Center 10". Only such "Center 10s" shall be called "Center tens".
- 325.6.2 Bolt lying on dividing line between scoring zone: Should the shaft of a bolt touch two (2) colors or touch any dividing line between scoring zones, that bolt shall score the higher value of the zones.
- 325.7 Missing lines on target face: Should a fragment of the target face





# IAU COMPETITION RULES

## FIELD CROSSBOW

be missing, including the dividing line or where two (2) colors meet, an imaginary line shall be used for judging the value of any bolt hitting such part.

Worn target faces shall be/will be replaced at the discretion of the Judges (Art. 312.2.a) or upon request.

325.8 Bolt on wrong target: A bolt hitting a target other than the Athletes' own target shall not score, and be counted as a "miss".

### 325.9 **Rebounds**

325.9.1 When a Rebound occurs, the athlete concerned shall complete the shooting of the end, remain on the Shooting line with his free hand held above his head or holding the signal flag (Art. 316.6.2) as a signal to a Judge, who shall then carry out the procedure outlined in Art. 325.9.2.

325.9.2 When all other athletes have completed shooting their three (3) bolts or the time limit has expired, the DOS shall interrupt the proceedings. A Judge, having satisfied himself that the claim was justified, shall allow the athlete concerned to shoot another bolt. Such a bolt shall be numbered or marked by the Judge in a way which will enable it to be identified in the target. At a signal from the Judge, the DOS shall give the signal for the competitors and Scorers to advance to the targets for scoring. The Judge shall Participate in the scoring and ensure that the correct number of bolts is scored, and that the Rebound was not caused by striking another bolt in the target.

325.9.4 Hanging Bolt: In the event of a bolt entering the target face and hanging from it, the athlete shall STOP SHOOTING immediately and Signal for a Judge as per Art. 325.9.1. When the shooting of that end has been completed by the other athletes, the Judge shall note the value of the bolt, remove it, mark the hole and place the bolt behind the target. The remaining bolts shall be shot by the athlete before the DOS orders general shooting to recommence. The Judge concerned shall participate in the scoring of that end.

325.9.6 Pass-Through (in Butt): In the event of a bolt which has entirely passed through the target face but which remains embedded in the butt, the scorer shall call for a Judge, who shall carefully push the bolt back through the butt in order that its scoring value may be judged. The Judge shall participate in the scoring and ensure that





# IAU COMPETITION RULES

## FIELD CROSSBOW

the bolt in question is correctly recorded on the athletes score sheet.

325.9.7 Pass-Through (Behind Butt): When a pass-through occurs, the athlete should adopt the Rebound Procedure (Art. 325.9.1), etc...

325.9.8 Disputes: In the event of a dispute over the scoring value of a bolt lying on a dividing line between zones, the scorer shall call for a Judge who shall decide upon the scoring value of the bolt in question. The decision of the Judge called shall be final and not subject to protest.

325.9.9 Score Validation: Where a judge is called upon to participate in the scoring of a bolt or an end, the appropriate entry/entries on an athletes' Score sheet shall be initialed by the judge involved (this entry must be made in red pen) and counter- initialed by the athlete concerned in the panel provided.

325.9.10 Corrections: A mistake on a score sheet, discovered before the bolts are drawn, may be corrected, but the correction must be witnessed and initialed (in red ink), by a judge and counter initialed by the athlete concerned, in the panel provided on the score sheet. Any other disputes concerning entries on a score sheet shall be referred to a Judge.

325.10 Bolts Left in Target Area: The DOS shall in consultation with the Judge ensure that, after scoring, no bolts are left in the targets before giving the signal to recommence shooting.

If bolts are inadvertently overlooked, the shooting shall not be interrupted. An athlete may shoot that end with other bolts, or make up the bolts lost, after shooting over that distance has been completed. A judge shall participate in the scoring after that end making sure that the bolts which remained in the target are checked back to the athletes' score sheet before any bolts are scored or withdrawn from the target.

325.11 Substitute Bolts: In the event of the athlete leaving bolts (e.g., on the ground in the target area), he may use others, provided he informs a Judge before shooting. The Judge shall exercise such checks as he deems fit in each circumstance.

325.12 Miss Due to Equipment Failure: An equipment failure during the shooting of an end: (i.e., a string or prod breakage), resulting in a miss, does not entitle the athlete to re-take a shot.





# IAU COMPETITION RULES

## FIELD CROSSBOW

- 325.13 Trigger Failure: A shot due to the self-release of the trigger mechanism, shall score according to the point of impact of the bolt. The crossbow shall be IMMEDIATELY (with no further shot taken) REMOVED from the shooting line for repair. In the event of an equipment failure, the athlete shall adopt the procedure specified in Art. 328.1.
- 325.14 Scoring Delegation: An athlete may delegate authority to score and collect his bolts to his NTM or another athlete on an adjacent target (within the official scorer's allocation), with the consent of the IJ.
- 325.15 Score sheets: Score sheets (provided by the OC) shall be signed by the scorer and the athlete denoting that the athlete agrees with the scoring value of each bolt.
- 325.15.1 In the absence of Independent Scorers, the athlete shall sign the score sheet denoting that he agrees with the distance and round totals.
- 325.16 Ties: In the event of a Tie in score, the results shall be determined as follows:
- 325.16.1 For Individuals: The athlete with the greatest number of scoring hits. If this is also a tie, then the athlete of those tying with the greatest number of Center ten hits entirely inside the 10 zone). If this is also a tie, then the athlete with the greatest number of hits scoring 10 points. If this is also a tie then the athletes shall be declared equal.
- 325.16.2 For Teams: The team having the athlete making the highest individual score. If this is also a tie, then the team having the athlete with the second highest individual score. If this is also a tie, then the teams tying shall be declared equal.



# IAU COMPETITION RULES

## FIELD CROSSBOW

### Art. 326 TARGET CROSSBOW LIMITS

Refer to Figure 6, Target Crossbow Limits

- 326.1 General: Any crossbow may be used which conforms to the following restrictions. All crossbows must be drawn by hand, without the aid of any mechanical device or finger protection whatsoever.
- 326.1.1 The crossbow must be equipped with a MECHANICAL TRIGGER. Such triggers must conform to Art. 326.3.2.
- 326.1.2 Crossbows must be fitted with a SINGLE bolt retainer (other than crossbows used with archery-style, clip-on nocks). The removal or malfunction of a bolt retainer will be deemed to render a crossbow UNSAFE and may result in the IMMEDIATE DISQUALIFICATION (Art. 335) if not repaired to the satisfaction of an IJ.
- FRONT MOUNTED bolt retainers are not permitted. The design of the bolt retainer shall conform to Figure F8.
- 326.1.3 Prod Assemblies: Prod assemblies may be made from any safe materials. Prods may be either of one-piece (1) or two-piece (2) Construction. Metal prod (bow limbs) and/or any form of wrapping or strapping of the bow limbs is forbidden. The maximum length of the prod when strung must not exceed 900 mm (refer to Figure F6).
- 326.1.4 Prods must be clearly and permanently marked to show draw weight and draw length, i.e., maximum design draw weight.
- The maximum permissible draw weight is 43 kilos (95 lbs.) irrespective of construction.
- 326.1.5 The Bow String: Bow strings and servings (where fitted) shall be made from non-metallic materials. Bow strings may be connected either directly to the limb tips (Art. 326.1.3), or by means of Axle-pins (fixed or pivoting, metallic or synthetic).
- String Loop attachments made from solid materials (synthetic or metallic) are NOT PERMITTED (refer to Figure F10).
- 326.1.6 Sights: The sighting system shall consist of no more nor less than two (2) separate open or diopter (aperture) sight Units, mounted in accordance with Figure F7 Sighting System Limits. If the front



# IAU COMPETITION RULES

## FIELD CROSSBOW

sighter consists of straight optical fiber, the length of fiber must not exceed 20 mm. Full length sight carrier rails may be used providing Art. 322.2 are complied with.

- 326.1.7 The maximum length from front sight to rear sight must not exceed 760 mm. The measurement is to be taken between two parts of sight with maximum distance (refer to Figure F7), without eye-cup.
- 326.1.8 The maximum length of the front sight tube must not exceed 60 mm. The length of the rear sight unit must not exceed 150 mm inclusive of anti-glare tube and eye shield. (Refer to Figure F7).
- 326.1.9 Equipment control: At WCH, CCH, WC, WCF, IC and CE sanctioned by the IAU, all Crossbows shall be checked by the TC and/or appointed persons supervised by an IJ prior to the Competition (Art. 334) and may be re-checked at any time during the Competition. The IAU Field, TC and/or the IJ may bar from the Competition any equipment which in their opinion is unsafe. At the competition of WCH, CCH, WC, WCF, IC and CE, competitors shall leave their shooting equipment on the Shooting Line and immediately retire behind the Waiting Line until such time as the IJ have inspected all equipment.
- 326.1.10 Recoilless Crossbows: Recoilless crossbows are permitted.
- 326.1.11 “Over-and-Under Tracks”: Crossbows fitted with “Over-and-Under” tracks are permitted provided that the upper track does not guide the bolt and that Art. 326.3.5 is complied with.
- 326.2 Permitted Accessories:  
The following accessories are permitted, provided the total weight of the crossbow with all accessories fitted does not exceed 10 kg (22 lbs.)
- 326.2.1 Foot Stirrups: Foot Stirrups attached to the stock or a separate foot plate to be used in conjunction with a stock-mounted eye-bolt are permitted, providing they comply with Art. 326.1.
- 326.2.2. Palm rests: An adjustable Palm rest or handle is permitted provided it does not extend beyond nor envelop the wrist.
- 326.2.3 Butt Plate and Butt hook: A fixed or universally adjustable butt hook /plate may be used, provided that:



# IAU COMPETITION RULES

## FIELD CROSSBOW

- a. The length of the butt hook, as measured between the deepest parts of the hook has a tangent to a line perpendicular with a line projected from the bolt axis, (A) does not exceed 153 mm. for all settings used by the athlete during a competition.
- b. The length of the uppermost protection (B), measured against the same references as (A), shall not exceed 30 mm, for all settings used by the athlete during a competition.
- c. The height of the lower projection of the butt hook (C), measured against the same references as (A), shall not exceed 30 mm, for all settings used by the athlete during the competition.
- d. Butt plates/hooks may be straight, cantered or offset with respect to the stock.
- e. Butt hooks must not bear directly on top of the shoulder.

Refer to Figure F9 for limits A, B and C.

- 326.2.4 Balance Weights, Extension Rods and “Torque Flight Compensators”: The athlete is allowed a free choice on the number and position of these accessories relative to the crossbow stock, provided they do not interfere with another athlete (on the shooting line) and that such extensions comply with (Art. 322.2 and Art. 326.3.3).
- 326.2.5 String Attachments: String Attachments i.e., separate string loops, archery type “nock-sets” or center nocking points (fixed or free-floating) are permitted, provided Art. 326.1.5 and Art. 326.3.9. are complied with.
- 326.2.6 Kisser Buttons (Head Checks): Kisser Buttons (to check head position) mounted on the stock, are permitted.
- 326.2.7 Bracing Strings: Prod Bracing Strings (bastard strings) are permitted.
- 326.2.8 Levels: The use of liquid Levels (level bubble) in the line of sight are permitted.
- 326.2.9 Cross-Over Prisms: The use of cross-over prisms (special rear sight adaptor enabling right-handed shooter to use left eye or vice versa) are allowed, provided Art. 326.3.7 and Art. 326.3.8 are complied with.



# IAU COMPETITION RULES

## FIELD CROSSBOW

- 326.3 Non-Permitted Accessories: The following accessories are not permitted:
- 326.3.1 Pistol Crossbows are NOT PERMITTED.
- 326.3.2 Electronic Equipment or Components on the crossbow, or used by the athlete either attached to or separate from the crossbow when on the shooting line are NOT PERMITTED, except as specifically otherwise provided for (Art. 330.1.6).
- 326.3.3 Crossbows equipped with Pneumatic or Hydraulic Devices are NOT PERMITTED.
- 326.3.4 Compound prods, and prod assemblies with mechanical moving parts (other than those defined under Art. 326.1.3), are NOT PERMITTED.
- 326.3.5 Attachments designed to guide the string along the track/stock, i.e., any form of sledge, bead or any other attachment designed to control lateral string movement along the track is NOT PERMITTED.
- 326.3.5.1 The length of the upper part of the string guide must not exceed 51mm (2 inch) - see Figure F8.
- 326.3.6 The use of Slings or Straps to steady the crossbow is NOT PERMITTED.
- 326.3.7 No Light enhancing system, optical system or telescope may attach to the crossbow.
- 326.3.7.1 The front or rear sights may have light or tinted lenses or polarizing filters, but the sights may not have any system of lenses.  
Micro-hole lenses are NOT PERMITTED as part of prescription spectacles (Art. 329).
- 326.3.8 A single corrective lens may be attached to the rear sight only; or the athlete may wear corrective or tinted lenses.
- 326.3.9 Vertical Crossbows (vertically mounted prod assemblies) are NOT PERMITTED.
- 326.4 The use of any attachments or equipment not mentioned in this specification must be submitted to and approved by the TC, at least six (6) months prior to equipment inspections of the competitions listed in Art. 301.

326.5 Dimensional Limits: Target Crossbow dimensional limits are described in:

- Figure F6 Target Crossbow Limits
- Figure F7 Sighting Equipment Limits
- Figure F8 Bolt retainer and string guide limits
- Figure F9 Butt hook Dimensional Limits
- Figure F10 String loop

Maximum Weights:

Draw weight (at string latch) 43 kg (95 lbs.)

Physical weight (with accessories) 10 kg (22 lbs.)

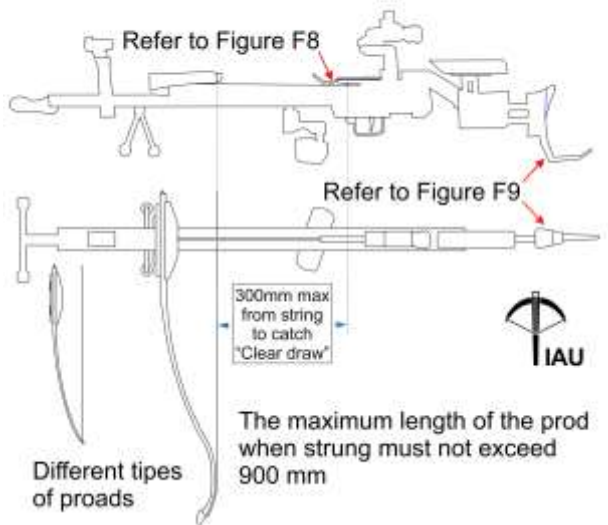

Figure F6: Target Crossbow Limits



Figure F7: Sighting Equipment Limits

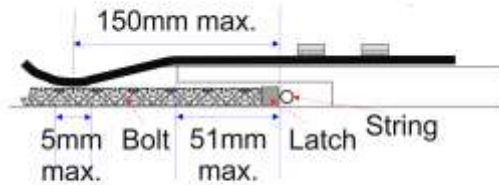

Figure F8: Bolt retainer and string guide limits

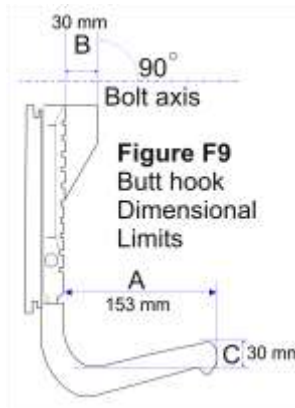
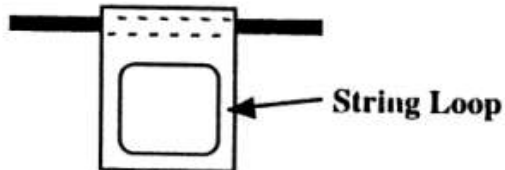

Figure F9: Butt hook Dimensional Limits





# IAU COMPETITION RULES

## FIELD CROSSBOW

Figure F10: String loop

String loop attachments made from solid materials (synthetic or metallic) are NOT PERMITTED (refer to Art. 326.1.5)

### Art. 327 BOLT SPECIFICATIONS

Refer to Figure F12 Bolt Specifications

- 327.1 Construction: Target crossbow Bolts (arrows) may be made from any safe materials and of such design as not to cause unreasonable damage to target butts.
- 327.1.1 Conical Points: Conical (chisel) points having an included angle of greater than 60° are NOT PERMITTED.
- 327.1.2 Slip-over Points: Bolts fitted with slip-over points (point diameter larger than shaft diameter) are permitted provided they comply with Art. 327.1 (damage to butts). Such points shall be no more than 2 mm greater than the diameter of the shaft.
- 327.2 Bolt Parameters: The permitted minimum / maximum bolts lengths are:
- |                       |                            |
|-----------------------|----------------------------|
| Minimum               | 304 mm (12 inches)         |
| Maximum               | 457 mm (18 inches)         |
| Maximum bolt diameter | 7,7 mm (i.e., Easton 1916) |
- 327.3 Vanes: Bolts must be fitted with Vanes (fletching). There is no restriction as to size or number.
- 327.3.1 Uniformity: All bolts in a set must have identical vane sizes and colors.
- 327.4 Markings: All bolts shall bear the name, initials or insignia of the athlete to which they belong. Such markings must be on each vane or on the bolt.

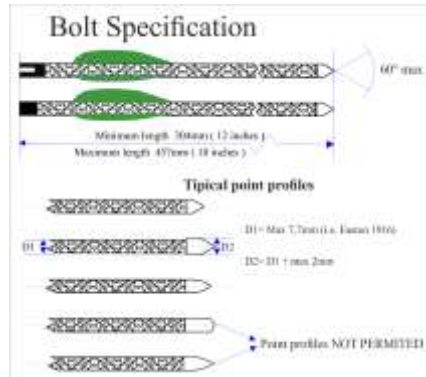

Figure F12: Bolt Specification (Refer to Art. 327)

## **Art. 328 EQUIPMENT FAILURE, REPAIRS AND INTERFERENCE**

- 328.1 Equipment Failure Procedure: in the event of a crossbow failure occurring during the shooting of an end, the athlete shall STOP SHOOTING IMMEDIATELY and step one (1) pace back from the Shooting Line holding the Flag provided (Art. 316.6.2) or his free hand above his head as a signal to the Judges.
- 328.1.1 Interference: in the event that a competitor is interfered with during the act of shooting, by a broken string or other part from another competitor, he may call a Judge, and invoke the Equipment Failure provisions of this Art. 328. The granting of another shot shall be at the sole discretion of an IJ.
- 328.2 Repairs: The IJ, having verified that the athlete was justified in leaving the Shooting Line, shall arrange with the DOS for the competitor concerned to effect repairs as follows:
- 328.2.1 Minor Defect Procedure: In the case of a minor defect: The DOS will delay his signal to advance for scoring until the athlete in question has completed his end of three (3) bolts.
- 328.2.2 Serious Defects: In the case of a more serious equipment failure: the competitor will be allowed a maximum of twenty (20) minutes to complete repairs for the current day of competition.



# IAU COMPETITION RULES

## FIELD CROSSBOW

Timing of such a repair period shall be undertaken by a Judge. A defect crossbow can be repaired by the competitor or any accredited person authorized by the competitor. The repaired crossbow will be checked by an IJ for compliance with Art. 326 and the time taken for such inspection shall not be included in the allowed 20-minute repair period.

In case of a Prod breakage, three (3) additional sighter shots may be taken in accordance with Art. 323.1. The competitor will then be allowed to make up the ends not shot after the completion of the distance.

328.3 Bolt Defects: No extra time will be allowed in the case of a bolt defect, i.e., damaged nock, loose vane, etc. (Art. 324.2).

328.4 Protocol for Making-Up Legitimate Shots: In the event of competitors having to make up shots at the end of a distance or of an end, the DOS will announce the target numbers and the number of bolts to be shot at each target.

The bolts will be shot one at a time under the direction of the DOS at the rate of ONE (1) minute per bolt [FORTY (40) seconds for 18m round] (with the lights showing GREEN for 30 [10 in 18m round] seconds, and AMBER for 30 seconds).

Each athlete will be supervised by a Judge who will ensure that “his” athlete leaves the line when he has shot the number of bolts announced by the DOS. Thus, all athletes who have bolts to shoot will shoot together for the first bolt, those with TWO (2) to shoot will remain on the line for their second shot and soon. The sequence will continue in groups of three (3) or four (4) bolts until all such legitimate bolts have been shot.

Note: twenty (20) seconds to approach the line will only be allowed at the beginning of each sequence.

### Art. 329 OPTICAL AIDS

329.1 Spotting Equipment: Field glasses, telescopes and other visual aids may be used for spotting bolts. Spotting telescopes may be set up on the Shooting Line. Where shooting takes place in two (2) Relays (Art. 321.1.2), the athletes must remove his spotting telescope and tripod to behind the Equipment Line when vacating





# IAU COMPETITION RULES

## FIELD CROSSBOW

the Shooting Line at the completion of an end of three shots (Art. 324.1). Spotting telescopes may be left on the shooting line when shooting in one (1) relay, at the Sole discretion of the DOS.

- 329.2 Spectacles: Spectacles as necessary or all types of special shooting spectacles (variable lens included), provided they are fitted with lenses normally prescribed for the user, and sunglasses are allowed, provided that they comply with (Art. 326.3.7.1). Spectacles shall not be marked in a way which can assist in aiming.
- 329.2.1 The special device (Gehmann or else) on the rear sight allowing to add prescription lens can be mounted. It's permitted only one optical correction possible: glasses or rear sight.
- 329.3 Inspection: Optical aids to be used by a competitor during the competition shall be inspected during equipment control and may be examined at any other time during the competition as required (Art. 334).

### **Art. 330 CLOTHING AND PERSONAL EQUIPMENT**

330. 1 Uniforms: At WCH, CCH, WC and WCF, sanctioned by the IAU, it is fitting that all competitors, NTM, Officials, etc. participating in Opening and Closing Ceremonies are dressed in the Uniform Dress of their respective federations.
- 330.1.1 Dress Standards: During the Competitions (and official practice sessions) the clothing worn by all Competitors shall be in traditional white color and conform to the following dress standards:
- Prohibited clothing: blue jeans (denim) or similar trousers in non-sporting colors, khaki or camouflage clothing, ragged cut-off shorts, trousers with patches or holes, inappropriate messages
- Female: dresses, skirts, slacks, culottes, or tailored shorts with a length not more than 15 cm above the center of the knee. Blouses or tops (long or short sleeved).
  - Men: trousers or tailored shorts with a length not more than 15 cm above the center of the knee. Shirts (long or short sleeved).





# IAU COMPETITION RULES

## FIELD CROSSBOW

A sweater, cardigan or track suit supplied to the competitor as official team uniform shall be permitted provided Art. 330.2 are complied with.

All such clothing shall be in the official colors of the federations participating, and shall be worn by all team members.

In the absence of a recognized National Team dress, competitors shall dress in plain white clothing.

The above-mentioned clothing shall be in accordance with Art. 330.2.

330.1.2 Inclement Weather: Weatherproof clothing made of a single layer of material may be worn during adverse conditions, only when this has been declared so by the DOS.

Such clothing shall comply with Art. 330.2.

330.1.3 Shooting Hats: Athletes is permitted to wear shooting hats which conform to IAU Field Division regulations.

330.1.4 Sound Dampening Apparatus: Athletes are permitted to wear ear plugs or hearing protectors (headphone type) provided that they do not prevent the wearer hearing acoustic signals (Art. 321.3) and that Art. 330.1.5 is complied with.

330.1.5 Personal Stereo Equipment: The use of personal stereo or radio equipment for music or self-coaching is NOT PERMITTED while on the shooting line, in Competition or official practice.

330.1.6 Personal timers: The use of mechanical or electronic personal timers by competitors or team officials is permitted (except smartphones), provided that NO audible alarm in signal is emitted.

Note: This clause does not relate to Judges.

330.1.7 Belts: Athletes are permitted to wear only one (1) belt, the width of which shall not exceed 30 mm If a belt quiver is worn, it must be attached to this belt.

330.1.8 Quivers: Belt or Pocket Quivers are allowed provided that Art. 330.1.7 is complied with.

330.2 Clothing: The use of special shooting jackets, padded clothing (single garment or combination of garments), tight clothing or accessories so designed to give support or improve performance,



- i.e., special shooting vests or undergarments is NOT PERMITTED (refer to Figure F12).
- 330.2.1 Gloves: The use of all gloves and special shooting gloves is NOT PERMITTED. All shooting must be done bare handed (i.e., the tapes are not permitted).
- 330.3 Footwear: Normal shoes shall be worn at all times during the Competition. The use of special shooting boots and shoes (except pistol ISSF shoes) is NOT PERMITTED.  
Footwear may not extend above the ankle bone.  
If doubt, the sole flexibility of the shoes may be controlled by the specific ISSF tester device.
- 330.3.2 Rubber Boots: Soft rubber boots or over-shoes are permitted in adverse weather conditions. Such footwear may not give support or aid performance, i.e., restrict ankle movement.
- 330.4 Competitor Numbers: At WCH, CCH, IC and CE all competitors shall wear their Competitor numbers on the middle of their back, and such numbers are to be visible at all times while an athlete is competing (refer to Art. 319.4).
- 330.5 Insignia: Athletes are permitted to wear the name or official insignia, flag or emblem of the federation or club which they represent on the shooting clothing / jacket. There is no restriction as to the size or color of such insignia etc.

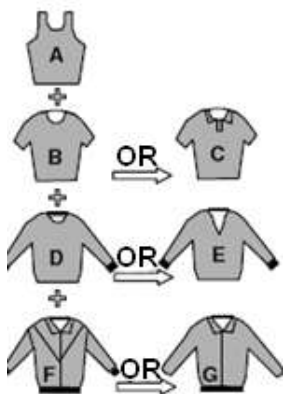

### Garment Types:

- A Vest (males) or undergarment (females)
- B Tee-shirt with short sleeves
- C Polo Shirt or shirt/blouse with short sleeves
- D Sweatshirt or Shirt/blouse with long sleeves
- E Sweater / Cardigan with long sleeves
- F Team Jacket / Tracksuit Top with long Sleeves
- G Weatherproof Jacket (when permitted by DOS)



# IAU COMPETITION RULES

## FIELD CROSSBOW

Figure F12: Clothing diagram

- This combination of garments is the MAXIMUM PERMITTED while shooting (refer to diagrams).
- No more than one (1) item of a given type of garment may be worn while shooting.
- All such clothing shall be loose fitting in compliance with Art. 330.1.1

330.6 Sponsors' Logos: An official Championships Emblem, or name, or name of venue or sponsor may be added to competitors' target back numbers and to officials' armbands, but must not distract from the numbers and letters.

330.7 Surgical Supports or Dressings: Competitors, who have sustained an injury requiring such treatment, must obtain permission to compete, or to continue to compete, from the IJC. The IJC may seek an opinion from a qualified medical practitioner. Permission will not be granted if the Competitor's ability to comply with Safety Rules (Art. 332) is impaired, or if the use of such surgical support or dressing could enhance performance in the Competition.

Competitors who must wear surgical support due to permanent disability, must provide a medical certificate to that effect and comply with the provisions of Art. 322 and this Art. 330.7.

### **Art. 331**                    **HERALDRY**

331.1                    Flags and Gonfalons: At Competitions sanctioned by the IAU it is permitted to display the flags or gonfalons (pennants) of Competing federations and/or individual clubs. Such flags or gonfalons may be set up behind the Waiting Line adjacent to the NTM' allocated positions.

### **Art. 332**                    **SAFETY AND COURTESY**

332.1                    An athlete MAY ONLY SPAN THE CROSSBOW WHEN ON THE SHOOTING LINE and after the signal to commence shooting an end has been given by the DOS or official in charge of shooting.





# IAU COMPETITION RULES

## FIELD CROSSBOW

- 332.1.1 NO AIMING “Dry - Firing” exercises are permitted if personnel are in front of the Shooting Line (Art. 332.5.b, 320.4).
- 332.2 The act of placing (nocking) a bolt must only be performed with the crossbow directed at the ground (or floor) immediately in front of the shooting line in the direction of the athletes’ allocated target butt.
- Placing a bolt in an elevated crossbow is NOT PERMITTED. Athlete who fails to observe this SAFETY RULE may be DISQUALIFIED.
- 332.2.1 The athlete concerned shall be cautioned by an IJ. An athlete repeating this offence shall be DISQUALIFIED from the Competition (Art. 335.2). If the spanned and loaded crossbow is lowered during the act of shooting an end the crossbow must not be turned aside from the direction of the athletes allocated target butt.
- 332.2.2 It is strongly recommended in the interests of PERSONAL SAFETY that the fingers of the hand which loads the bolt be kept straight and pointing away from the trigger latch, i.e., towards the front of the crossbow.
- 332.3 At the signal to stop shooting from the DOS, the crossbow must IMMEDIATELY BE LOWERED, the BOLT REMOVED and the STRING LOWERED (UNLATCHED).
- 332.4 If a defect occurs in the crossbow during the shooting of an end, the athlete must STOP SHOOTING IMMEDIATELY and signal to a Judge in accordance with Art. 328.1.
- 332.5 It is forbidden:
- TO USE THE CROSSBOW IN AN UNSAFE CONDITION.
  - To aim at people even though the crossbow is not spanned nor a bolt loaded.
  - To handle the crossbow carelessly on the Shooting Line.
  - To shoot vertically. The spanned and loaded crossbow shall not be raised to an elevation higher than the top of the wind flag of the competitor’s designated target.
  - To span a crossbow with other Competitors, spectators or officials in front of the Shooting Line.



# IAU COMPETITION RULES

## FIELD CROSSBOW

- f. To leave the Shooting Line with a spanned or loaded crossbow.
  - g. To place a spanned and/or loaded crossbow on the ground or floor.
  - h. To allow unsupervised persons not acquainted with these Safety Rules to handle the crossbow.
- 332.5.1 Mandatory for your personal safety:
- a. Long hair must be tied back or otherwise security retained
  - b. Necklaces must not hang loose (i.e., shall be kept inside the clothing)
  - c. Tie-cords on the clothing must not hang loose.
- 332.6 Courtesy: Target crossbow shooting is a demanding sport enquiring great concentration, therefore a competitor should:
- a. NOT talk in a loud voice when others are shooting.
  - b. NOT talk to another competitor who obviously prefers to remain silent.
  - c. NOT make any exclamation on the Shooting Line which may disconcert a fellow competitor in the act of taking a shot.
  - d. NOT walk up and down the Shooting or Waiting Line comparing scores.
  - e. NOT handle another competitor's equipment without permission
  - f. When calling scores do so commencing with the highest score first, i.e., 10, 9, 8.
- 332.7 At no time shall an athlete advanced the target for any reason while others are shooting nor until the signal to advance has been given by the DOS or official in charge of shooting.
- 332.8 The smoking (including electronic cigarette) is prohibited all the time of Competition in space of waiting line and shooting line for every person bar none.



# IAU COMPETITION RULES

## FIELD CROSSBOW

### **Art. 333 ASSISTANCE AND COACHING**

333.1 While on the Shooting Line (sighting or competition shots), a competitor may receive no coaching or assistance of any kind from any person, for the purpose of improving his performance or score, spotting the hits on the target face, or indicating any adjustments.

At the completion of an end of sighters or scoring shots, only verbal advice can be given to the shooter. No other person has the right to touch the shooter's crossbow, make adjustments, change or repair the crossbow between ends of shooting (use the Art. 328.2 procedure).

Should an athlete receive such coaching, he shall be cautioned by a Judge. An athlete repeating this offence may be barred from the day's Competition. (See Art. 335.2).

333.2 A Competitor may delegate the scoring of his shots to his NTM or a fellow Competitor on an adjacent target (Art. 325.14). A Judge shall be informed of such delegation.

333.3 All connected devices (watches, glasses,) are FORBIDDEN.

### **Art. 334 EQUIPMENT CONTROL**

334.1 At WCH, CCH, IC or CE sanctioned by the IAU, on the day of official practice or before, all crossbows and each athlete's shooting equipment, accessories and clothing shall be checked for compliance with the provisions set out in these Competition rules, by the IJ/TC and its appointed representatives at an official equipment control session (which is to be held prior to official practice) in accordance with the announcement made in the official program of the event.

334.2 Crossbows and bolts shall be checked for compliance with (Art. 326 and Art. 327). Suitable measuring instruments and weighing scales (duly certified by an appropriate body) shall be made available by the OC. Due care shall be taken by the IJ/TC and its appointed representatives not to damage any equipment.

A sample of prods may be weighed at scrutineering prior to shooting. IJ/TC may request that random prods be weighed after the completion of all Competition shooting and for place getters,





# IAU COMPETITION RULES

## FIELD CROSSBOW

at their sole discretion.

- 334.2.1 Control Stickers: Crossbows having been approved as correct shall be marked with a suitable sticker bearing the name and date of the Competition. The approval must also be indicated on a Control Card, provided by the OC, in accordance with the format specified.
- 334.2.2 Spare Crossbows: Spare crossbows to be used in the case of equipment failure, Finals event etc., must also be submitted for approval during equipment control at the time appointed by the Organizers. Refer to Finals Rules Art. 350.
- 334.2.3 After equipment has been approved, it must not be altered at any time prior to or during the Competition in any way that would conflict with these Rules. If there are any doubts regarding an alteration, the equipment must be returned to Equipment Control for re-inspection and approval.
- 334.2.4 An athlete found to be using unapproved or altered equipment or having removed official Control Stickers will face IMMEDIATE DISQUALIFICATION (Refer to Art. 335).  
Further inspection of equipment such as in the case of equipment failure shall take place as appropriate.
- 334.3.1 Crossbows, bolt and clothing of the leading five (5) competitors in each division will be re-checked for compliance with (Art. 326, Art. 327 and Art. 330) of these Competition Rules, by the TC and/or IJ BEFORE such equipment is removed from the equipment Line at the completion of each Competition round. The IJ may elect to inspect all competitors' equipment at the completion of a Competition round, at its discretion, provided that this is appropriately announced.
- 334.4. Approval of the equipment is valid only for the Competition which the inspection was made.



# IAU COMPETITION RULES

## FIELD CROSSBOW

---

### **Art. 335**                    **DISCIPLINARY ACTION**

- 335.1                    Competitors and Officials are to conform to the IAU Constitution and Rules as well as any decisions and directives made by the IJC.
- 335.2                    An athlete shown to have unknowingly violated any Rule or Regulation shall be given a verbal warning by a Judge and informed that any further violation could be cause for disqualification. Warning shall be expressed by showing a YELLOW CARD with the word 'WARNING'. This warning must also be shown to the NTM of the competitor in question.
- 335.2.1                An athlete proved to have knowingly violated any Rule or Regulation and having been shown the Yellow (Warning Card) (Art. 335.2), shall be ruled, by the IJ, not to be eligible to participate and shall be disqualified from the Competition. Disqualification shall be expressed by showing a RED CARD with the word 'DISQUALIFICATION'.
- Note: The size of the cards should be approximately 70x100 mm.
- 335.3                    The NTM may appeal against such a decision to the Jury of Appeal (Art. 336.2), immediately and in writing. The appeal shall be handed to an IJ for delivery. The decision of the Jury of Appeal is final.
- 335.4                    All Yellow and Red card incidents shall be recorded on all of the offending Competitor's score sheets for the remainder of that Competition. The offences shall be noted on the athlete's record card and noted for the next WCH or CCH. The DOS shall also be notified.
- 335.5                    National Team Managers (NTM): At all times during the days of Competition, the NTM, his Assistant, or his Representative shall be in attendance. If the NTM requires leaving the Competition, he must notify the IJ of this fact and who his representative is.
- The OC shall provide the IJ with a NTM list.



# IAU COMPETITION RULES FIELD CROSSBOW

## **Art. 336 PROTESTS, APPEALS AND HIGHER APPEALS**

- 336.1 Protests and Appeals: All questions or disagreements regarding the interpretation of Competition Rules or actions taken by championships officials must first be decided by the IJC in accordance with Art. 311 and Art. 337.
- 336.1.1 Appeals: The NTM or Federation Official may file an appeal against a decision of a Judge or Scorer to the IJC immediately and in writing. The IJC must immediately investigate the matter and make a decision on the appeal. No protests can be made about the scoring value of a bolt (Art. 325.9.8).
- 336.1.2 Higher Appeals: In the event of a disagreement with the IJC decision, the NTM or Federation Official may file a Higher Appeal in writing (Art. 336.3) to the Jury of Appeal.
- 336.2 Jury of Appeal: A Jury of Appeal shall be appointed by the EC for every IAU sanctioned event. The Jury of Appeal is responsible for making final decisions on all appeals against decisions by the IJC (Art. 311.2). The Jury of Appeal shall consist of three Members including a Chairman, being a senior member of the TC, an EC member knowledgeable in Field Division Rules and an IAU-knowledgeable person from the OC.
- 336.2. 1 The Jury of Appeal must be available at the Competition field at all times during the championships including the day of official practice until 30minutes after the end of shooting.
- 336.3 Protest Fee: All higher appeals must be submitted in writing by the NTM or his representative not later than one hour after the IJC decision and be accompanied by a fee of 50€ or its equivalent. The fee shall be returned if the appeal is upheld and shall be retained by the OC (50% to IAU funds) if the appeal is lost. In special circumstances, the time for submitting appeals may be extended up to twenty-four (24) hours by decision of the Jury of Appeal. Such decision can postpone the victory ceremony for the event under appeal.
- 336.4 Decisions made by the Jury of Appeal must be documented and submitted to the appellant, the Chairman of the IJC and the Chairperson of the OC before the awarding of prizes. This terminates the path of appeal.



# IAU COMPETITION RULES FIELD CROSSBOW

## **Art. 337**            **PRECEDENCE, INTERPRETATION AND AMENDMENTS**

- 337.1            Amendments to these Rules can only be made in accordance with Article 13 of the IAU Constitution.
- 337.2            The general interpretation and maintenance of these rules shall be the responsibility of the Field Division TC.
- 337.2.1        For any special exceptions to the above rules the permission of the Executive Committee of the IAU must be obtained.
- 337.3            In cases of difficulties arising out of differences in the interpretation of these rules, the original English text shall prevail. Where there is a conflict between these rules and the IAU Constitution, the latter shall take precedence.
- 337.4            Gender: References to the male gender shall import the female gender and conversely, except where the context indicates that the flatter is gender-specific.
- 337.5            Expressions: The following expressions are defined:
- MUST           indicates a mandatory requirement which cannot be waived,
- SHALL          expresses a mandatory requirement,
- SHOULD        expresses a requirement which is desirable,
- WILL            express a declaration of purpose which is rigid,
- MAY            expresses a declaration of purpose which is flexible.

## **Art. 338**            **WCH/CCH ADMINISTRATION**

Reserved

Refer also to “Guidelines for the conduct of World and Continental Championships”.

## **Art. 339**            **ADVERTISING AND SPONSORSHIP**

339. 1           Advertising: At WCH, CCH, IC and CE sanctioned by the IAU, any form of commercial advertising to be used to sponsor or promote the event may only be done with the written permission of the IAU EC.



# IAU COMPETITION RULES FIELD CROSSBOW

---

## INTERNATIONAL CROSSBOW SHOOTING UNION FIELD DIVISION COMPETITION RULES IAU Match Play



# IAU COMPETITION RULES

## FIELD CROSSBOW

### Art. 350 IAU Match Play

- 350.1** The IAU Match Play consists of 30 Qualification shots on 35m (18m indoor) and eliminations. The results of the qualification round are used to create the draw for the eliminations.
- 350.1.1 The IAU Match Play round consist of maximum five ends of three bolts in a 40 cm reduced 3-spot target face (Art. 317.1.1) at 35-meter distance for outdoor and 23,65 cm 3-spot full ring target face at the 18-meter indoor distance (Art 315) for each elimination round. The time allowed shall be three (3) minutes per three bolts (2 minutes for Indoor). Two ends of three (3) sighter bolts in five (5) minutes (3 minutes for Indoor) shall be shot at the commencement of the IAU Elimination 35m (18m Indoor). Such sighters shall not be scored.
- 350.1.2 The elimination round consists of all the competitors who participated in the qualification round, at the same time on the shooting line, in form of duels. Each end consists of 3 bolts in three (3) minutes according the Art .351.19 Schedule of Elimination Rounds.350.1.3 If there are less than 6 shooters in a Category, eliminations shall not be held.
- Except where otherwise specified in these Special Technical Rules, current IAU Target Crossbow Rules will apply in their entirety. Re-scrutiny of all equipment (334) and all back-up equipment.
- 350.2 Tied Scores: If after 30 Qualification shots, there is a tie for any position (involving two or more competitors and after considering standard tie-breaking procedures), the ranking will take into account tens, then nines, eights, and so on. If the result is still tied, winner will be determined in a shot-off. The shoot-off consist on one shot, the shooting time is 40 seconds. The Athlete whose shot is the nearest to the center is declared the winner.
- 350.2.1 Elimination round: Athletes are paired in duels according to the Qualification ranking (picture, rule 350.10). In a duel, the Athlete with the higher scoring end shall get 2 points. In case of a tie, both shooters get one (1) point each. The shooter, first to reach five (5) points is qualified for the next elimination round.
- In case of a tie, the winner will be determined in a shot-off. The winners from semi-final duels go to final and shoot for gold medal



# IAU COMPETITION RULES

## FIELD CROSSBOW

and the losers go to duel for bronze medal.

350.2.2 In a medal match, the first athlete to reach five (5) points is declared the winner. If there is a tie (5:5), the winner will be determined in a shoot-off. The shoot-off consist on one shot, the shooting time is 40 seconds. The Athlete whose shot is the nearest to the center is declared the winner.

350.2.3 The winner will get the title IAU World (Continental) Champion IAU Match Play Man/Woman/Junior/Cadet/Senior man/Senior woman/Assisted shooter in discipline Field.

350.2.4 Open Team Competition

Open team consist of three athletes regardless the Category and sex. The IAU National Member federation shall announce maximum of two national open teams designed before the first qualification shot.

Qualification: All teams that participated in the qualification round shall qualify to shot in IAU Match Play eliminations.

Elimination Round: Teams are paired in duels according to the Qualification ranking (picture, rule 350.10). All three Athletes from each team shoot at the same time. In a duel, the Team with the higher scoring end shall get 2 points. If the score is equal, both teams get one (1) point each. The team, first to reach five (5) points is qualified for the next elimination round. In case of a tie, winner will be determined by a shoot-off. The winners from semi-final duels go to final and shoot for gold medal and the losers go to duel for bronze medal.

350.2.5 In a medal match, the first team to reach five (5) points is declared the winner. If there is a tie (5:5), the winner will be determined in a shoot-off. The shoot-off consist on one shot of one member of the team representative, with shooting time of 40 seconds. The shot who is the nearest to the center is the winner.

350.2.6 Target Assignment: targets shall be allocated according to the individual competitors' ranking and duel pairing at the completion of the IR 300 qualification Round.

The Shooting line is covered in order by Men, followed by Women, Juniors, Cadets, Senior men and Senior women.

350.2.7 Athletes (Teams) who do not have an opponent (bye) in a Match-





# IAU COMPETITION RULES

## FIELD CROSSBOW

- Play round may shoot the first three ends of the round. These ends will not be scored.
- 350.3.1 The highest scoring competitor in each category (Men, Women, Juniors, Cadets, Senior (men, women) and Assisted Shooters) shall be assigned to the lowest possible target number. The remaining targets are to be allocated in order of duel pairing (Art 350.10).
- 350.3.2 Reporting Time: the athlete must report at their assigned shooting stations 10 minutes before the scheduled starting time for the appropriate Elimination round.
- 350.4 Back Numbers: each athlete shall wear a Back Number bearing Target Number (1-16), Family Name, Country (abbreviation).
- 350.5 Sighters: at the beginning of elimination, two (2) ends of three (3) sighter bolts shall be shot. Such sighter bolts shall not be scored. The maximum time limit for sighters shall be five (5) minutes. Athletes are required to retrieve their own bolts.
- 350.6 There will be no sighting shots before the medal matches, but there will be a separate training field set up, with a reasonable safety distance from the finals field.
- The training for the first medal match of the day shall start 20 minutes before the start time of the first medal match round. If there are multiple medal matches shot one after another, every next training will start at the same time as the preceding medal match round.
- 350.7 Judges: the DOS shall be assisted by two (2) IJs who will respectively supervise the elimination and be responsible for deciding the scoring value of bolts.
- 350.8 The organizing committee shall provide sufficient Field Judges (FJ's), announcer, technician for electronic data processing, couriers, TV cameraman's, light technicians.



# IAU COMPETITION RULES

## FIELD CROSSBOW

- 350.9 Field Equipment: the following additional equipment will be required for the IAU Match Play Round:  
electronical scoring Board shall be used.  
The display screen(s) must be large enough and clear visible for spectators and media, light show, advertising boards, flags of participants...
- 350.9.1 Music only during the breaks, not while the shooting.
- 350.10 Schedule of IAU Match Play Rounds



# IAU COMPETITION RULES FIELD CROSSBOW

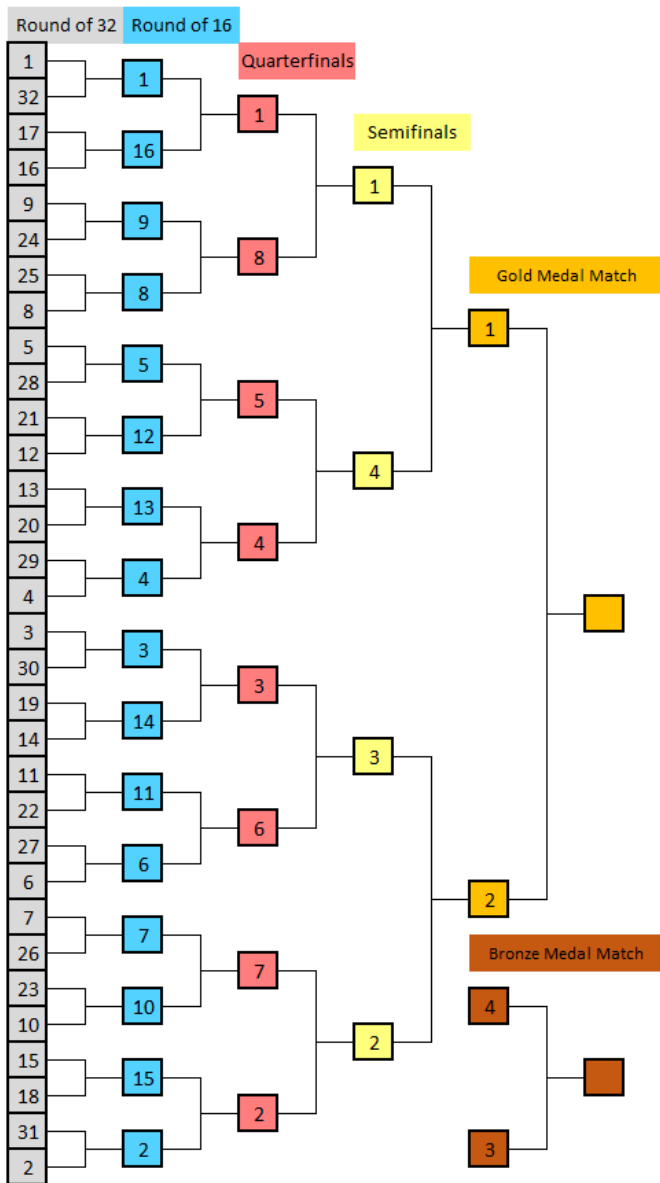



# IAU COMPETITION RULES

## FIELD CROSSBOW

- 350.11 **Time Control and Commands in Elimination rounds:**  
The announcer will introduce shooters in ¼ Finals, ½ Finals, Bronze Finals and Gold Finals starting 5 minutes before preparation time.
- 350.11.1 The DOS shall control shooting of the Elimination with the following amplified voice commands:
- 350.11.2 **“Five (Two) minutes preparation time is starting now!”** Valid only for 1/8 Finals and ¼ Finals. ½ Finals, (Two minutes is for Bronze Finals and Gold Final.  
Countdown begins. Finalists may take up their assigned positions on the shooting line. Practice of the shooting stance is permitted in accordance with Art. 320.4. Traffic lights set to RED.  
Announcer clarifies the rules in this part of the competition and gives other important information’s.
- 350.11.3 After five (two) minutes: **“Stop, Preparation time is finished!”**
- 350.11.4 **“This is your first sighting end. Three bolts in five minutes”.**  
After five (two) minutes:  
**“Stop the shooting, collect your bolts.”**
- 350.11.5** After second sighter end:
- 350.11.6 “One minute to elimination”**  
After one minute:  
**“This is your first, second...fifth elimination end: three bolts in three minutes”**  
After three minutes:  
**“Stop the shooting, score the targets.”**  
The competitors stop the shooting and going to target line, together with IJ’s and scorers and scoring the results. Competitor with the highest score get two points, the looser get zero (0) points. This result is mechanical or electronic put to the scoring flip board under the left target face (2:0). The shooter, who gets first five (5) points, is qualified for the next final and the duel is finish.  
The announcer from time to time publishes the actual results, do





# IAU COMPETITION RULES

## FIELD CROSSBOW

- some interviews with present important persons, winners or losers.
- 350.11.7 When the scoring value of the bolts has been verified and recorded on scoring board and by an IJ on score sheets provided by the organizers, the IJ shall permit the shooters to withdraw the bolts and return with it to the refuge.
- 350.11.8 In the bronze and gold final, the results are announced by an IJ in order: Last name, shots (best to worst), and round total.  
Results announced by the IJ are scored by independent scorers. The other judge(s) must check the score sheets. If there are no independent scorers, the results are scored by a judge and checked by another judge.
- 350.11.9 Pullers for bronze and gold final: the IJs shall be assisted by Pullers who will be designated by the Finalists to pull their bolts, i.e., eight (8) Pullers (1 per Finalist).
- 350.11.10 Runners for bronze and gold final: the Organizing Body shall provide two Runners to ensure that the bolts are returned to the Finalists between ends. The IJs are responsible for the supervision of the runners under the direction of the DOS.
- 350.11.11 In case of equipment failure during the final shooting, the shooter shall get one (1) minute extra time to change the failure crossbow to the reserve crossbow. Such a crossbow must be check by the equipment control.
- 350.11.12 Appeals: in the case of a dispute as to whether or not a bolt is touching a dividing line between scoring zones, the majority decision of All Three (3) IJs shall be final and not subject to further appeal.
- 350.11.13 Award Ceremony: the presentation of awards shall take place in front of the main spectator area at the conclusion of each Final.
- 350.12 **Suggested time schedule for world championship**
- |        |                                 |             |
|--------|---------------------------------|-------------|
| Day 1  | Arrival of teams, Open training | 12:00-16:00 |
| Sunday |                                 |             |
| Day 2  | Open training                   | 10:00-16:00 |



# IAU COMPETITION RULES

## FIELD CROSSBOW

---

Monday	Delegates Meeting and VIP, Draw for target assignments – Open Competition Reception	17:30-18:00
Day 3	Open Competition	09:00-16:00
Tuesday	Awards ceremony	17:00-17:30
	Draw for target assignments	18:00-19:00
Day 4	Official training	09:00-15:30
Wednesday	Technical control	08:00-16:30
	Opening ceremony	18:00
Day 5		
Thursday	<b>IAU Classic Round and Qualif. Match Play</b>	09:00-16:00
	Flowers ceremony, Individual and Team	16:30-17:00
Day 6		
Friday	IAU Match Play Semi-final Rounds Individuals	09:00-12:00
	IAU Match Play Semi-final Rounds Open Team	13:00-16:00
Day 7	IAU Match Play Medal Matches Individuals	09:00-12:00
Saturday	IAU Match Play Medal Matches Open Team	13:00-16:00
	Ind. and Open Team Awards IAU Match Play	15.00
	Closing Ceremony	16:00
	Banquet	19:00
Day 8		
Sunday	Departure of Teams	

(Similar timetable for Indoor in Art 351.23)



# IAU COMPETITION RULES FIELD CROSSBOW

---

## **INTERNATIONAL CROSSBOW SHOOTING UNION FIELD DIVISION COMPETITION RULES WORLD CUP FINALS 35m, 18m**



# IAU COMPETITION RULES

## FIELD CROSSBOW

---

### **Art. 351 WORLD CUP FINAL ROUNDS - 35m/18m**

- 351.1 The IAU World Cup Final will be organized every year, as a conclusion of the IAU World Cup Series. The Qualification for the IAU World Cup Final is possible by position on the actual IAU World rank list.
- 351.2 WCF is a competition that requires full media and marketing attention.
- 351.3 At the end of the IAU World Cup Series in IAU World Cup Final (best term is middle of September for 35m Outdoor and middle of November to beginning of December for 18m Indoor), the best sixteen (16) crossbow shooters from IAU Ranking List in category Field Men, Field Women highest qualification values will qualify for the IAU World Cup Final.
- 351.4 If the Qualification Values are the same the higher Qualification rank will count.
- 351.5 Within one (1) event, only a maximum of four (4) crossbow shooters per nation will be permitted to compete in the IAU World Cup Final.
- 351.9 Entry fee for Field WCF is 100 Euro.
- 351.10 Qualification for WCF consists of Outdoor 35m or Indoor 18m IR 300 round for 16 crossbow shooters.
- 351.11 Elimination of sixteen (16) to winner shot all the shooters at the same time on the shooting line as a duel ends each for 3 bolts in three (3) or two (2) minutes according the Art .351.18.4 Schedule of Elimination Rounds
- 351.12 The winner will receive title World Cup Final Champion Man/Woman in discipline Field.
- 351.13 Following Articles IAU Field Rules Will Apply: 315, 318.2.1, 318.4.1, 318.4.3.1, 318.4.4.4, 324.1.1.
- 351.14 Except where otherwise specified in these Special Technical Rules, current IAU Target Crossbow Rules will apply in their entirety. Re-scrutiny of all equipment (334) and all back-up equipment.



# IAU COMPETITION RULES

## FIELD CROSSBOW

- 351.14.1 Music only during the breaks, not while the shooting.
- 351.15 The World Cup Finals shall consist of 2 rounds: QUALIFICATION and ELIMINATION.
- 351.16 QUALIFICATION round:
- 351.16.1 Reporting Time: The Qualification shooters must report at their assigned shooting places 10 minutes before the scheduled starting time for the appropriate Qualification round.
- 351.16.2 Target Assignment: targets shall be allocated according to draw for the firing positions among the 16 competitors.
- 351.16.2.1 Firing position for all 16 shooters shall be similar (ground, lightening and so one).
- 351.16.2.2 In case of equipment failure during the final shooting, the shooter shall get one (1) minute extra time to change the failure crossbow to the reserve crossbow. Such crossbow must be checked by the equipment control.
- 351.16.3 Back Numbers: each Finalist shall wear a Back Number bearing Target Number (1-16), Family Name, Country (abbreviation).
- 351.16.4 Sighters: at the beginning of Classification round two (2) ends of three (3) sighter bolts shall be shot. Such sighter bolts shall be recorded but not be scored. The maximum time limit for sighters shall be five (5)/three (3) minutes. Shooters are required to retrieve their own bolts.
- 351.16.5 Qualification round shall be shot by all shooters in one line at 35m/18m distance and consist of ten (10) ends each for three (3) bolts in three (3)/two (2) minutes.
- 351.16.5.1 Scoring: shall take place after each end. On the command from the DOS, the IJ together with competitors and scorers will go to the targets for scoring. One (1) scorer shall to be appointed for every four (4) competitors.
- 351.16.6 Tied Scores: if after the 30th Classification shots there is a tie for any position (involving two or more competitors and after considering standard tie-breaking procedures), the ranking will take into account Center tens, then tens, nines, eights, and so on, then last to first end. If the result is the still tied, the winner will be determined in a shoot-off. The shoot-off consist on one shot,



# IAU COMPETITION RULES

## FIELD CROSSBOW

the shooting time is 40 seconds. The Athlete whose shot is the nearest to the center is declared the winner.

- 351.17 ELIMINATION round:
- 351.17.1 Elimination of sixteen (16) to winner e.g.: 1<sup>st</sup> vs 16<sup>th</sup>, 2<sup>nd</sup> vs 15<sup>th</sup>, 3<sup>rd</sup> vs 14<sup>th</sup>, 4<sup>th</sup> vs 13<sup>th</sup> etc. (See Art 350.10) shot at the same time on the shooting line a duel ends each for 3 bolts in three (3) Outdoor or two (2) minutes Indoor and the winner get 2 points. In equal both shooters get one (1) point. The shooter, who get five (5) points is qualified for the eight-final between best eight and then to semi-final between best four shooters. In case of tie, the winner will be determined in a shoot-off. The shoot-off consist on one shot, the shooting time is 40 seconds Indoor and 60 seconds Outdoor. The Athlete whose shot is the nearest to the center is declared the winner.
- 351.17.2 The process of rating hits goes as follows: in 1/8, ¼ and ½ Finals competitors themselves score the value of the arrows, as in qualifications. In Bronze and Gold Final only International Judges score the value of the arrows. During that time, the competitors are on the shooting line.
- 351.17.3 The winner will receive title World Cup Final Champion.
- 351.18 In General
- 351.18.1 Judges: the DOS shall be assisted by two (2) IJs who will respectively supervise the World Cup Finals and be responsible for deciding the scoring value of bolts.
- 351.18.2 The organizing committee shall provide sufficient Field Officers (FOs), announcer, technician for electronic data processing, couriers, TV cameraman's, light technicians.
- 351.18.3 Field Equipment: the following additional equipment will be required for the Final Round: Electronical Scoring shall be used. The display screen(s) must be large enough and clear visible for spectators and media, light show, advertising boards, flags of participants...
- On the stand targets should be placed sheets flip boards with numbers from 1-6. size A4.

The figure F13 below shows the layout and position.

Figure F13: Field scoring Equipment



351.18.4

### Schedule of Elimination Rounds

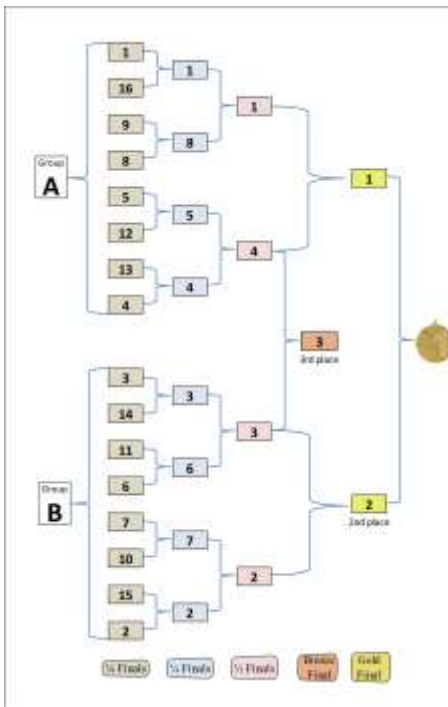



# IAU COMPETITION RULES

## FIELD CROSSBOW

- 351.19 **Time Control and Commands in Elimination rounds:**  
The announcer will introduce shooters in 1/8 Finals, 1/4 Finals, 1/2 Finals, Bronze Finals and Gold Finals starting 5 minutes before preparation time.
- 351.20 **The DOS shall control shooting of the Elimination with the following amplified voice commands:**
- 351.20.1 **Five (Three) minutes preparation time is starting now!** Valid only for 1/8 Finals and 1/4 Finals. (Three minutes is for 1/2 Finals, Bronze Finals and Gold Finals).  
Countdown begins. Finalists may take up their assigned positions on the shooting line. Practice of the shooting stance is permitted in accordance with Art. 320.4. Traffic lights set to RED.  
Announcer clarifies the rules in this part of the competition and gives other important information's.
- 351.20.2 After five (three) minutes: **“Stop, Preparation time is finished!”**
- 351.20.3 **“This is your first sighting end. Three bolts in three minutes”.** Valid only for 1/8 Finals, for 1/4 Final, 1/2 Finals, Bronze Final and Gold Final - NO Sighters.  
After five (two) minutes:  
**“Stop the shooting, collect your bolts.”**
- 351.20.4 After second sighter end:
- 351.20.5 **“One minute to elimination”**  
After one minute:  
**“This is your first, second...fifth elimination end: three bolts in two minutes”**  
After two minutes:  
**“Stop the shooting, score the targets.”**  
The competitors stop the shooting and going to target line, together with IJ's and scorers and scoring the results. Competitor with a highest score get two points, the looser get zero (0) points. This result is mechanical or electronic put to the scoring board under the left target face (2:0).



# IAU COMPETITION RULES

## FIELD CROSSBOW

---

- The announcer from time to time publishes the actual results, do some interviews with present important persons, winners or losers.
- 351.20.6 When the scoring value of the bolt has been verified and recorded on scoring board and by an IJ on score sheets provided by the organizers, the IJ shall permit the shooters to withdraw the bolt and return with it to the refuge.
- 351.20.7 In the bronze and gold final the three IJs shall relay the scoring values back to the speaker, who will announce the winners name and points and the name of loser. Shooters staying on shooting line.
- 351.20.8 Pullers for bronze and gold final: the IJs shall be assisted by Pullers who will be designated by the Finalists to pull their bolts.
- 351.20.9 Runners for bronze and gold final: the Organizing Body shall provide one runner to ensure that the bolts are returned to the Finalists between ends. The IJs are responsible for the supervision of the runner under the direction of the DOS.
- 351.20.10 In the bronze and gold final applause and positive cheering of audiences are allowed.
- 351.21 Appeals: in the case of a dispute as to whether or not a bolt is touching a dividing line between scoring zones, the majority decision of All Three (3) IJs shall be final and not subject to further appeal.
- 351.22 Award Ceremony: the presentation of awards shall take place in front of the main spectator area at the conclusion of each Final.



# IAU COMPETITION RULES

## FIELD CROSSBOW

### 351.23 Suggested time schedule for World Cup Final

<b>Day 1</b>	- 12.00	arrival of participants
	12.00	IAU Meetings (Team leaders, TC, EC)
	13.00 - 13:45	Training women (Technical control men)
	14:00 - 14:40	Training men (Technical control women)
	15.00	30 shots women (qualification)
	16.00	30 shots men (qualification)
<b>Day 2</b>	09.30	women 1/8 final – elimination
	09.40	men 1/8 final -elimination
	10:20	men and women ¼ final – elimination
	11.00	men and women ½ final – elimination
	13:00	Opening ceremony, Artistic program
	13.30	women bronze FINAL – 3 <sup>rd</sup> place
	14.00	men bronze FINAL – 3 <sup>rd</sup> place
	14:30	women gold FINAL – 1 <sup>st</sup> place
	15:00	men gold FINAL – 1 <sup>st</sup> place
	16:00	Victory ceremony - WCF
	17:00	Music and cultural program
	17:30	Photo shoots and friendly meeting of spectators and sport stars
19.00	Banquet and the Award Ceremony the Best World crossbow shooters Man and Woman	
<b>Day 3</b>	- Departure of delegations	



**IAU COMPETITION RULES  
FIELD CROSSBOW**

---

**INTERNATIONAL  
CROSSBOW SHOOTING  
UNION  
FIELD DIVISION  
COMPETITION RULES  
IAU Rank List,  
IAU World Cup  
And  
IAU World Cup Final**



# IAU COMPETITION RULES

## FIELD CROSSBOW

---

### **Art. 360 IAU World Cup and IAU World Cup Final**

#### **360.1 General**

- 360.1.1 In case of discrepancy in this regulation, the English version is valid (original)
- 360.1.2 World Cup events must be approved by IAU EC
- 360.1.3 A contract for the World Cup event must be signed by both sides (organizer / IAU)
- 360.1.4 The period of a World Cup starts on the 1st of January and ends on the 31st of December in each year.
- 360.1.5 The Entry fee of EUR 100 shall be paid for the participation of each athlete. A fee of 50 EUR for officials (team leaders, coaches, accompanying persons) shall be paid. All Entry fees will be paid to the IAU account, no later than 7 days before the 1st day of the competition, based on an invoice issued by the IAU
- 360.1.6 Two doping tests are carried out on a one (1) competition day. One (1) for male athletes and one (1) for female athletes. Usually, the winners; or by draw or by setting the jury.
- 360.1.7 The World Cup Final (WCF) is not subject to any doping controls. The IAU may at any time order doping controls. The cost of doping controls at a WCF is paid by the IAU.
- 360.1.8 World records are recognized according to the respective IAU rules.

#### **360.2 Participation authorization:**

- a.) Athletes whose federation is a member of the IAU or WCSA
- b.) Any athlete who owns an IAU ID number
- c.) If the registration for the WC competition has been made by the member federation
- d.) If there are not enough starting places, the number of athletes per nation is limited.

#### **360.3 Shooting programs**



# IAU COMPETITION RULES

## FIELD CROSSBOW

Subsequent shooting programs can be advertised at a World Cup event.

360.3.1 Field division IAU Classic, according IAU Rules Field division  
IAU Match Play according IAU Rules

360.4.1 Points are awarded to the athletes in the men's and women's categories (No Class Division) at each World Cup competition, WCH or CCH and the WCF.

### 360.4.2 Scoring points system

Place	WCH, CCH, WC	WCF
1.	80	80
2.	70	70
3.	60	60
4.	50	50
5.	45	45
6.	40	40
7.	35	35
8.	30	30
9.	25	25
10.	22	22
11.	20	20
12.	18	18
13.	16	16
14.	14	14
15.	12	12
16.	10	10
17.	9	
18.	8	
19.	7	
20.	6	
21.	5	
22.	4	
23.	3	
24.	2	
25.	1	





# IAU COMPETITION RULES

## FIELD CROSSBOW

---

360.4.2.1 The EC IAU will designate the Director of the scoring and drafting of the IAU World Ranking List.

### 360.4.3 **Score-equality**

In case of point-equality, the ranking must be established as follows:

360.4.3.1 By the highest number of points in the World or Continental Championship, then last, second last, third last competition of the World Cup series and so on.

360.4.3.2 By the highest result in the World or Continental Championship, then last, second last, third last competition of the World Cup series and so on.

360.4.3.3 If there is still a tie, the athletes must get the same rank.

### 360.5 **Nomination World Cup Final**

Is an independent World Cup event and is divided into field crossbow and match crossbow.

360.5.1 The order of the athlete is determined by the respective world ranking list.

360.5.2 Each division is divided into 2 categories: men, women.

360.5.3 Maximum of 16 men and 16 women have the right to enter the Competition

360.5.4 Each participating national federation is limited to the maximum of 4 participants per category

360.5.5 The shooting order will be determined according to the participants' ranking position on the IAU world ranking list following the above rule

360.5.6 In the event that an athlete who has the right to compete cancels his/her participation in the event, he/she will be designated as WNP (will not participate)



# IAU COMPETITION RULES

## FIELD CROSSBOW

- 360.5.7 Competitors designated as WNP will automatically be placed at the end of the WCF qualification order, and the reserve 4th participant from the same country will be moved to the third place, 5th to 4th and so on
- 360.5.8 In case all the 16 places within a category cannot be filled due to a small number of participants, the allowed number of participants per country will be increased to 5, and if even that is not enough, to 6.
- 360.5.9 The reserve 4th competitor will automatically be placed lower on the qualification order than the competitors who entered the competition in accordance with the regular rule, regardless of the points in ranking.
- 360.5.10 National federations must confirm or cancel the participation of their team members in the shortest possible time.
- 360.5.11 The IAU shall publish new WCF qualification order, with new alternate athletes without delay and inform the federations about participation rights
- 360.5.12 If there is a tie in the world ranking list, the IAU-EC decides.

### **World Cup Final - Field Division**

- 360.6 1st Day, Training, Qualification & Elimination  
2nd Day, Elimination & Final
- 360.6.1 **Qualification:**  
Program: Outdoor IR300 35m or Indoor 18m
- 360.6.2 **Elimination:**  
Program: Outdoor 35m or Indoor 18m
- 360.6.2.1 The placement for the first (1) round in the elimination competition is based on the results of the qualifying competition
- 360.6.2.2 The determination of the ranking 1 - 16 takes place by means of elimination procedures according to the drawing Final-Sheet-Field in direct competitions (duel) between 2 athletes at the same time.



# IAU COMPETITION RULES

## FIELD CROSSBOW

360.6.2.3 A duel ends after 3 arrows in two (2) minutes indoor 18m or (3) minutes outdoor 35m.

360.6.2.4 The winner gets 2 points.

360.6.2.5 In case of a tie both athletes get one (1) point.

360.6.2.6 The first athlete to reach five (5) points will qualify for the next Round. If there is a tie (5: 5), the winner will be determined in a shoot-off

### 360.6.3 **Final:**

Program: Outdoor 35m or Indoor 18m

360.6.3.1 The winners of the semi-final duels fight for the gold medal.

360.6.3.2 The losers from the semi-final duels fight for the bronze medal.

360.6.3.3 Is a direct competition (duel) between 2 athletes at the same time.

360.6.3.4 A duel ends after 3 arrows in two (2) minutes indoor 18m or (3) minutes outdoor 35m

360.6.3.5 The winner gets 2 points.

360.6.3.6 In case of a tie both athletes get one (1) point.

360.6.3.7 The first athlete to reach five (5) points is the winner. If there is a tie (5:5), the winner will be determined in a shoot-off

### 360.6.4 **Shoot Off**

Is a direct competition (duel) between 2 athletes at the same time.

360.6.4.1 The shoot-off consists on one shot. The shot who is the nearest to the center is the winner.

### 360.6.5 **Placements**

360.6.5.1 The rankings of 5 - 8 will be awarded to the losers of round 2 on the basis of their qualification result.

360.6.5.2 The 9-16 rankings will be awarded to losers in round 1 based on their qualification result.

## 360.7.0 **World Cup Final - Match Division**



# IAU COMPETITION RULES

## FIELD CROSSBOW

- 360.7.1 Competition program: Match Crossbow under point 3
- 360.7.2 The final is to be done in accordance with IAU Match Rules 218

### **360.8.0 Awards**

- 360.8.1 Awards are given in each category (men, women).
- 360.8.2 **Women - IAU Crossbow Shooter of the Year**
  - 360.8.2.1 This title will be awarded based on the current IAU World Ranking List after the Women's World Cup Final. The ceremony takes place at the World Cup final.
- 360.8.3 **Men - IAU Crossbow Shooter of the Year**
  - 360.8.3.1 This title is awarded based on the current IAU World Ranking List after the World Cup Final Men. The ceremony takes place at the World Cup final
- 360.8.4 **Women - World Cup Final Winner**
  - 360.8.4.1 Is the winner of the World Cup Final in the women category
- 360.8.5 **Men - World Cup Final Winner**
  - 360.8.5.1 Is the winner of the World Cup Finals in the Men category



# IAU COMPETITION RULES FIELD CROSSBOW

---

## History of Changes to the IAU Field Rules

In the preceding rules some articles were amended during the IAU Field TC Meetings:

Breda (NDL) July 1985,  
Annala (FIN) July 1987,  
Rohrbach (AUT) July 1987,  
Wolverhampton (GBR) July 1989,  
Açoteias (POR) September 1990,  
Wil (SUI) August 1991,  
Hamilton (NZL) January 1992,  
Wiesbaden (GER) July 1994,  
Tainan (TPE) November 1996,  
Ringgenberg (SUI) July 1997,  
Otrokovice (CZE) July 2004,  
Wil (SUI) December 2004,  
Sankt Petersburg (RUS) September 2007,  
Zürich, Geneva (SUI) January 2009,  
Bratina (CRO) August 2012,  
Innsbruck (AUT) September 2013,  
Moscow (RUS) November 2015,  
Zürich (SUI) July 2016,  
Moscow (RUS) December 2017,  
Pärnu (EST) July 2018,  
Orel (RUS) November 2018,  
Ulyanovsk (RUS) August 2019,  
Dubrava, Ivanić Grad (CRO) December 2019,  
Online videocall, Zoom app, December 12, 2020  
Online videocall, Zoom app, April 22, 2023



# IAU COMPETITION RULES FIELD CROSSBOW

---

Straßburg (FRA) Oktober 2024

Online videocall, Zoom app, March 22, 2026  
and now in force.

IAU President

IAU Field TC Chairman

Pero Stojnic  
Croatia

Andreas Henne  
Switzerland



# IAU COMPETITION RULES FIELD CROSSBOW

## 370 Annexes

### 370.1 Part 1 - IAU Identification Number (IAU ID Number)

- 1) To participate in IAU supervised championships and competitions it is mandatory for all crossbow shooters to have an IAU Identification Number (IAU ID Number).
- 2) In order for an IAU ID Number to be issued, the crossbow shooter's IAU Member Federation must submit an application on the form that follows. The IAU guest, a citizen of a country that is not a member of the IAU, can independently apply for the IAU ID.
- 3) Each crossbow shooter must be a national of the country that they represent and must provide a copy of the passport with their application.
- 4) Each crossbow shooter may only apply for one (1) IAU ID Number.
- 5) A fee of Euro 10.00 is charged for the issue of each IAU ID Number. Express application (issue within one (1) week) increases the fee to Euro 20.00.
- 6) The IAU Member Federations must send all applications for IAU ID Numbers to the IAU. Only typed or e-mail application(s) will be accepted.
- 7) The IAU will send the IAU Member Federations a list with all new IAU ID Numbers within 14 days after the application(s) are submitted. The IAU Member Federations must check and approve this list and return it to the IAU. No response will be taken as approval.
- 8) If a crossbow shooter changes his/her name or nationality, the IAU must be notified without delay, so that necessary changes can be made by the IAU. The original IAU ID Number will not change, but the IAU must correct data associated with the IAU ID Number.

\_\_\_\_\_

Place

\_\_\_\_\_

Date

\_\_\_\_\_

Signature crossbow athlete

\_\_\_\_\_

In case of minor age, name of legal representative

\_\_\_\_\_

Signature of legal representative



# IAU COMPETITION RULES FIELD CROSSBOW

## Part 2: Application by IAU Member Federation

The IAU Member Federation of:	
-------------------------------	--

herewith applies for the issue of an IAU ID Number which is necessary for the participation in IAU supervised competitions and championships for the following crossbow athlete:

Family Name(s):			
Given Name(s):			
Maiden Name(s):			
Nationality:			
Gender:	Male <input type="checkbox"/>	Female <input type="checkbox"/>	
Date of Birth	Day:	Month:	Year:
Event(s):	Field <input type="checkbox"/>	Match 10m <input type="checkbox"/>	Match 30m <input type="checkbox"/>
Name who signs for federation:			
Signature of federation:			
Date:			



# IAU COMPETITION RULES FIELD CROSSBOW

## Part 3 – Crossbow Shooter Agreement

I agree that the IAU may publish my information below on the official website Personal and sport associated data:

<b>Surname</b>				X	
<b>Given Name</b>				X	
<b>Year of Birth</b>				X	
<b>Gender</b>	Male <input type="checkbox"/>	Female <input type="checkbox"/>		X	
<b>Place of birth</b>				X	
<b>Hometown</b>				X	
<b>Residence (3 letter code)</b>				X	
X				<b>Publishing</b>	
<b>Marital status</b>	Single <input type="checkbox"/>	Married <input type="checkbox"/>		Yes <input type="checkbox"/>	No <input type="checkbox"/>
<b>Children</b>				Yes <input type="checkbox"/>	No <input type="checkbox"/>
<b>Profession</b>				Yes <input type="checkbox"/>	No <input type="checkbox"/>
<b>Hobbies</b>				Yes <input type="checkbox"/>	No <input type="checkbox"/>
<b>Languages</b>				Yes <input type="checkbox"/>	No <input type="checkbox"/>
<b>Club</b>				Yes <input type="checkbox"/>	No <input type="checkbox"/>
<b>Start of competing</b>				Yes <input type="checkbox"/>	No <input type="checkbox"/>
<b>Shooter since</b>				Yes <input type="checkbox"/>	No <input type="checkbox"/>
<b>Personal Coach</b>				Yes <input type="checkbox"/>	No <input type="checkbox"/>
<b>National Coach</b>				Yes <input type="checkbox"/>	No <input type="checkbox"/>
<b>Handedness</b>	Right <input type="checkbox"/>	Left <input type="checkbox"/>		Yes <input type="checkbox"/>	No <input type="checkbox"/>
<b>Events</b>	Field <input type="checkbox"/>	Match 10m <input type="checkbox"/>	Match 30m <input type="checkbox"/>	Yes <input type="checkbox"/>	No <input type="checkbox"/>
<b>Other sport activities</b>				Yes <input type="checkbox"/>	No <input type="checkbox"/>

---

**Place**

---

**Date**

---

**Signature crossbow athlete**

[iau-crossbow.org](http://iau-crossbow.org)  
[office@iau-crossbow.org](mailto:office@iau-crossbow.org)

Ch. des Vernets 2 – C.P. 169  
 2035 Corcelles, Switzerland

Page 105



# IAU COMPETITION RULES FIELD CROSSBOW

---

**In case of minor age, name of legal representative      Signature of legal representative**

## **370.2 IAU Crossbow Athlete Declaration**

### **IAU Crossbow Athlete Declaration**

**1) I hereby confirm that I am aware of the regulations and penalties in force for the official competitions of the IAU relating to the fight against doping.**

**2) I agree to submit to the doping control tests, to accept the results of such tests and to abide by the respective regulations in their prevailing form at any given time.**

**3) I agree that any dispute arising between myself and the IAU which cannot be settled amicably and which remains once the procedures provided for in the IAU regulations have been exhausted, shall be settled finally by a tribunal composed in accordance with the Statutes and Regulations of the Court of Arbitration for Sport, Lausanne, Switzerland, to the exclusion of any recourse to ordinary courts. The parties undertake to comply with the said Statutes and Regulations, accept the award rendered, and in no way hinder its execution.**

**The IAU fully accepts the WADA Anti-Doping regulations.**

---

<b>Place</b>	<b>Date</b>	<b>Signature crossbow Athlete</b>
--------------	-------------	-----------------------------------

---

**In case of minor age, name of legal representative**

\_\_\_\_\_ **Signature of legal representative:**



# IAU COMPETITION RULES FIELD CROSSBOW

---

370.3

## AGREEMENT WITH THE NATIONAL SPORTS FEDERATION AS AN ORGANIZER OF IAU

---

Between  
**INTERNATIONAL CROSSBOW SHOOTING  
UNION**

(hereinafter referred to as the “IAU”)

And

---

(hereinafter referred to as the “Organizer”)

**due to the organization of the**  
**IAU WCH, CCH, WC or WCF**



# IAU COMPETITION RULES FIELD CROSSBOW

## Recitals

By the decision of the IAU Executive Committee (EC), at the meeting held

it has been decided to entrust the holding of the IAU **WCH, CCH, WC or WCF** in year \_\_\_\_\_ to the \_\_\_\_\_ Federation in accordance with Article 2b and 18 of the IAU Statutes.

The Parties, the organizing National Federation represented by \_\_\_\_\_, hereinafter referred to as the “Organizer”, and the IAU Executive Committee represented by the President Pero Stojnic, hereinafter referred to as the “IAU”, have agreed as follows:

## Introductory provisions

### Article 1

(1) Based on the application submitted and the decision made by the IAU EC, it was decided to hold the **WCH, CCH, WC or WCF** in \_\_\_\_\_

in the period from \_\_\_\_\_ to \_\_\_\_\_.

(2) The purpose of this Agreement is to confirm the appointment of the Organizer as the host country of the **WCH**, as well as to determine the duties and responsibilities of the parties, both the IAU and the Organizer and its Organizing Committee for holding the **WCH, CCH, WC or WCF**.

## List of regulatory documents

### Article 2

The IAU shall confirm the appointment of the above Organizer as the Organizer of the **WCH, CCH, WC or WCF**, which is to be held in \_\_\_\_\_ (place and country), as well as shall fulfil all the duties and obligations to hold the **WCH**, provided for by the IAU Rules.





# IAU COMPETITION RULES FIELD CROSSBOW

The Organizer of the **WCH, CCH, WC or WCF** shall comply with all the provisions of the IAU Statutes and the Rules of the sport type.

## **Article 3**

- (1) The IAU and the Organizer agree that both parties will make every effort to create the best conditions for the athletes to display their abilities in conditions of fair competition during the **WCH, CCH, WC or WCF** and to put crossbow shooting in the most favorable light for the IAU member federations, viewers and media.
- (2) The Organizer of the **WCH, CCH, WC or WCF** hereby assumes all the obligations to prepare, host, hold and organize the **WCH, CCH, WC or WCF** and shall comply with all the requirements set forth herein.

## **Article 4**

- (1) The Organizer shall accept its appointment as the Organizer of the **WCH, CCH, WC or WCF** and confirm that it understands and will fulfill the duties and obligations entrusted by the Rules for Crossbow Shooting Sport.
- (2) The Organizer will establish an Organizing Committee and guarantees that the Organizing Committee will fulfill all the duties assigned to it.
- (3) The Organizer shall be liable for managing and holding the **WCH, CCH, WC or WCF** via the Organizing Committee.
- (4) The Organizing Committee includes a management team, rank-and-file employees, national referees and volunteers who jointly plan, prepare all the aspects and hold the **WCH, CCH, WC or WCF** under the IAU supervision.

## **Article 5**

The Organizer of the **WCH, CCH, WC or WCF** shall comply with all the provisions of the IAU Statutes and the Rules of the sport, as well as with





# IAU COMPETITION RULES FIELD CROSSBOW

the conditions for Organizing the **WCH, CCH, WC or WCF**, presented in the bid.

## Participation

### Article 6

The Organizer shall assume the responsibility for inviting all the National Member Federations of the IAU,

## Participation fee

### Article 7

(1) The Participants shall pay to the IAU, participation fees for the participation in the **WCH, CCH, WC** in accordance with the decision of the IAU Executive Committee, Pärnu, July 1, 2018 and Orel, December 8, 2018.

(2) A fee of EUR 150 for **WCH, CCH**, 100 EUR for **WC and WCF** shall be paid for the participation of each athlete in each competition. A fee of 50 EUR for officials (team leaders, coaches, accompanying persons) shall be paid.

(3) The last day of registration is two weeks before the first day of the competition. Late registration will be charged with 50 EUR per person.

(4) All Entry fees for **WCH, CCH and WC** will be paid to the IAU account (details is in Article 24) no later than 7 days before the start of the competition. All Entry fees for **WCF** will be paid to the Organizer no later than 7 days before the start of the competition.

(5) The total amount, reduced by EUR 20 per competitor, payment for officials and late registration, must be transferred from IAU to the organizers (details is in Article 25.) of the competition within 10 working days after the start of the competition (Not for **WCF**).



# IAU COMPETITION RULES FIELD CROSSBOW

---

## Officials

### Article 8

- (1) The IAU Executive Committee shall introduce a candidate of the IAU Technical Delegate to the Organizer.
- (2) The IAU Technical Delegate shall be responsible for inspection of the shooting ranges and other facilities in order to confirm their compliance with the IAU standards and suitability for the **WCH, CCH, WC or WCF**. The IAU Technical Delegate shall coordinate his work with the Organizer before and during the **WCH, CCH, WC or WCF**.
- (3) In order to fulfil his duties, the Technical Delegate must be invited at the expense of the Organizer to the venue of the Championship not later than three (3) days before the official training.

### Article 9

- (1) The Organizer of the WCH shall appoint judges and the Press Officer and agree the candidates with the IAU Executive Committee.
- (2) The Organizer shall assist IAU International Judges, who will serve the **WCH, CCH, WC or WCF**, with costs of the transportation, hotel accommodation, meals and local transport).
- (3) The maximum number of these IAU Officials is 5 per IAU Division (Field and Match). This number is determined by the Technical Delegates and EC IAU in agreement with the organizer.

## Sports grounds: requirements for the sports infrastructure

### Article 10



# IAU COMPETITION RULES FIELD CROSSBOW

- (1) The Organizer shall prepare the shooting ranges, equipment installed and other sports infrastructure facilities, which shall meet the relevant requirements.
- (2) The **WCH, CCH, WC or WCF** which will be held under the IAU supervision in accordance with the IAU Rules.

## **Key personnel**

### **Article 11**

- (1) The Organizer shall train judges, officials, technical and administrative personnel before the **WCH, CCH, WC or WCF** in accordance with the IAU Technical Rules.
- (2) The Organizer shall ensure optimal working conditions for the officials responsible for the **WCH, CCH, WC or WCF**, judges, as well as for representatives of the media in accordance with the established rules and standards and the needs of certain bodies and services.

## **Procedure of the competitions**

### **Article 12**

- (1) The Preliminary and Final Programs of the **WCH, CCH, WC or WCF** shall be prepared by the Organizer and submitted to the EC IAU at first and after confirmation to the IAU WEB page and IAU Member Federations.
- (2) The Organizer shall develop a procedure and rules for the conduct of competitions in accordance with the IAU Rules.

## **Requirements for the transport and hotels, standards, infrastructure**

### **Article 13**



# IAU COMPETITION RULES FIELD CROSSBOW

- (1) The Organizer shall take special care in choosing the accommodation, meal and transportation option for the participants, which must comply with generally accepted international standards for hotel, catering and transportation services, and ensure safety of the participants, employees, IAU official representatives and guests of the Championship.
- (2) The organizer must ensure the price in the hotels does not exceed the actual price in each of the hotels during the championship period.
- (3) The Organizer shall provide free transportation to all delegations from the competition venues to the hotel and from the hotel to the shooting ranges.
- (4) The Organizer may also be required to pay any expenses on the transfer for the participants and officials from/to the airport if such decision is approved by the IAU Executive Committee.

## **Article 14**

(1) The hotels that host the participating National Federations and the IAU Officials must comply with international standards and should be located as close as possible to the shooting ranges. It is desirable that the organizer offer a few different quality standards for hotel accommodation, which is adequate for the prices.

The cost of the accommodations provided for the competitors and personnel should correspond to market price, or be less than market price.

(2) The Organizer shall not organize a transfer to/from a hotel not provided for in the program.

## **Anti-doping control**

## **Article 15**



# IAU COMPETITION RULES

## FIELD CROSSBOW

Anti-doping control is conducted throughout the duration of the Championship in accordance with the IAU Anti-Doping Regulations and the World Anti-Doping Code.

Anti-doping control is conducted on the last day - 3 samples, all by drawing of the winners by the disciples.

All the costs associated with the organization of anti-doping control during the Championship shall be paid by the Organizer.

### **Advertising events and interaction with media during the IAU WCH, CCH, WC or WCF**

#### **Article 16**

(1) The Organizer shall develop the concept and prepare proposals and initial information for the Championship promotion campaigns in order to attract media attention to the competitions.

(2) The rights to cover all the Championships in the media, the rights to broadcasting them and advertising belong to the IAU.

(3) In order to assist the Organizer, some of these rights may be granted to the IAU National Member Federation of the host country.

(4) It is necessary to provide maximum assistance to employees of the press, radio and television in order to ensure free circulation of public information for media representatives.

(5) The Organizer must agree with the national broadcasting company (or with local or commercial TV companies) that it will act during the Championship as the main TV company providing the live broadcast of the Championship on IAU websites, TV and radio broadcasting.

### **Obligations of the Organizer**

#### **Article 17**



# IAU COMPETITION RULES FIELD CROSSBOW

Within 30 days after the end of the **WCH, CCH, WC or WCF**, the Organizer shall send a report on the **WCH, CCH, WC or WCF** (Appendix 1).

The organizer must send by email the results and pictures (or links to the pictures) at the end of each day of the competition to the IAU Secretariat. At the end of the competition the Final Book of Results in electronic form also must be sent by email to the IAU Secretariat. The Original Results Book signed by the Technical Delegate, the Jury Chairperson, the Competition Director, and the Organizer's Representative must be handed over to the Technical Delegate.

## **Refusal from holding the **WCH, CCH, WC or WCF****

### **Article 18**

(1) The Organizer agrees that it has the right to refuse, in full or in part, from the performance of its obligations to hold the **WCH, CCH, WC or WCF** only with the consent of the IAU Executive Committee.

Unauthorized refusal entails a penalty. The minimal amount of the penalty is 5000,00 EUR and shall be determined by the IAU Executive Committee after the proceedings for each case of refusal individually. These funds will be used to help future organizers

In case the penalty is not met, the organizing Member Federation may face a suspension of membership in the IAU, as well as a temporary ban on participation in the competitions held under the IAU supervision (according to the decision of the IAU Executive Committee).

(2) In case of the cancellation of the **WCH, CCH, WC or WCF** by the IAU, the IAU agrees to repay the organizer the initial investment in the organization of the **WCH, CCH, WC or WCF**, which is 6500,00 EUR.

(3) In case the Organizer is prevented from holding the **WCH, CCH, WC or WCF** due to the measures instated by the country of the Organizer (e.g., Covid 19 measures by the national civil protection authority, War situation in the country or neighboring countries, the recommendation of the International Olympic Committee), the IAU shall give the consent to



# IAU COMPETITION RULES FIELD CROSSBOW

postpone or cancel the **WCH**, **CCH**, **WC** or **WCF**. Such cancellation entails no penalties, neither by the IAU nor by the Organizer.

## **IAU help**

### **Article 19**

The IAU will offer the Organizer to use the Program for processing results at the competition.

The possibility of helping the Organizer who accepts the organization of the Competition in a short period of time. This decision must be approved by the EC IAU:

## **Governing law and jurisdiction**

### **Article 20**

(1) This Agreement shall be governed and interpreted solely by the Swiss laws.

(2) Any disputes under this Agreement, including on its conclusion, binding force, amendments and termination hereof, shall be submitted to the Court of Arbitration for Sport in Lausanne, Switzerland, and settled in accordance with the Court of Arbitration for Sport. The language of the proceedings shall be English.

## **Validity**

### **Article 21**

(1) This Agreement shall enter into force upon its signature by the parties and remain in force until the final report on the results of the competition is submitted.

(2) Upon the expiration of the above period, this Agreement shall automatically terminate without the right of either party to compensation, except for violation of its terms and conditions.





# IAU COMPETITION RULES FIELD CROSSBOW

---

## **Amendments**

### **Article 22**

Amendments hereto shall have legal effect only if made in writing.

## **Number of identical copies**

### **Article 23**

This Agreement is made in two identical copies, one for each party.

### **Article 24**

#### **IAU account details:**

IAU-Accountant IAU-Headquarters, ICP-Services,

Les Vernets, P. O. Box 169, CH-2035 Corcelles, Switzerland

CHF-Account Raiffeisenbank Flawil, Magdenauerstrasse 1, CH-9230  
Flawil, Switzerland

IBAN: CH25 8132 5000 0080 1714 1 BIC: RAIFCH22D25

EUR-Account Raiffeisenbank Flawil, Magdenauerstrasse 1, CH-9230  
Flawil, Switzerland

IBAN: CH27 8132 5000 0080 1710 5 BIC: RAIFCH22D25

Account Name: International Crossbow-Shooting Union, CH-2035  
Corcelles, Switzerland

Important! For all payments it is essential to enter the complete address.



# IAU COMPETITION RULES FIELD CROSSBOW

## Article 25

### Organizer account details:

“.....full name.....”

“.....address in details.....”

“.....ID number.....”

“IBAN: .....”

“SWIFT: .....”

“name of Bank and address in details”

On behalf of IAU	On behalf of the organizing National Federation
Name: Pero Stojnic	Name: .....
Title: IAU President	Title: .....
Date	Date
seal	seal



# IAU COMPETITION RULES FIELD CROSSBOW

---

## **Appendix 1**

Report

Related to *Article 17*

Deadline: Within 30 days after the end of the WCH, the Organizer shall send a report on the WCH.

1. Does the OC pay for Venue use? If yes, how much?

2. Financial indicators

2.1. External Revenue

- Local city and tourism commission support
- State and federal government – sport ministry
- National Olympic Committee
- Sponsors

2.2. Internal Revenue

- Entry fees
- Training fees
- Hotel
- Food and drink
- Merchandise
- Currency Exchange Rates
- Additional contents

2.3. Expenses

- Staff
- Range personnel and judges
- IJs and IAU TD



# IAU COMPETITION RULES FIELD CROSSBOW

- Transportation
- Doping
- Ceremonies (Opening/Closing, Victory)
- Protocol
- Professional technician's and result service
- TV productions
- Supplies total
- The supplies that remained for the future
- Miscellaneous
- Copy machine & printers
- Cleaning & trash
- Other – Contingency Expense

3. Please your conclusion about the next

3.1. WCH HIGHLIGHTS:

3.2. PROBLEMS OR ISSUES:

3.3. LESSONS LEARNED:

IAU - International Crossbow Shooting Union, Vrbik 22, 10000 Zagreb,  
[office@iau-crossbow.org](mailto:office@iau-crossbow.org)

Notice: This report serves the IAU to statistically monitor the organization of various competitions in different countries.



# IAU COMPETITION RULES FIELD CROSSBOW

## Article 370.4 APPLICATION FORM FOR AN IAU OFFICIAL COMPETITION

Name of Federation:		
Hereby applies for a:		
Title of event:		
To be held at		
on (preferred dates)		
Disciplines:	Field	Match

Name of OC Secretary:			
Address of OC Secretary:	Address:		
	Phone:		
	Fax:		
	E-mail:		

Please answer the following questions	Field		Match	
	outdoor	indoor	10m	30m
Direction of shooting				
Number of firing points available				
Target manufacturer				
Is there a separate Finals range?				
Do all ranges comply with current IAU Rules? Yes or No			Yes	No

If "NO" please specify:

Venue owner	Government/Military	
	National or Regional Shooting/Crossbow Federation	
	Shooting/Crossbow Club	
	Private (Name of owner)	
	Other	

Previous events:



# IAU COMPETITION RULES FIELD CROSSBOW

Please specify the last IAU International event that your Federation has hosted at this venue:

Event:

Date:

### Travel and Accommodation:

Name of airport	
Distance from ranges to nearest airport with international connections	km
Approximate distance from ranges to nominated official hotels	km
Approximate travel time	minutes

### Hotel ratings and approximate daily costs (night/breakfast) in EUR:

	5 Star	4 Star	3 Star	Other
Single				
Double				

### Internet:

What kinds of internet connections are available at the venue for?

Upload		Download	
--------	--	----------	--

### Regulations:

Please give an explanation below of any National Laws or Local Regulations of which the IAU and its National Federations should be informed, e.g. "Importation of crossbows and bolts":

We declare that we will sign an agreement with the IAU at least one year before the start of the competition.

Signature	Title/position	Date

*Application form sends to the address: [office@iau-crossbow.org](mailto:office@iau-crossbow.org)*





# IAU COMPETITION RULES FIELD CROSSBOW

---

## Article 370.5 APPLICATION FORM FOR IAU FIELD JUDGES LICENSE ISSUING AND RENEWING

1. **Address Details of Applicant:**  
Mr. / Mrs. / Ms.  
Last Name:  
First Name:  
Address:  
Phone:  
E-mail:  
Country:
2. **Nationality:**
3. **Languages spoken:**
4. **Judging status** (National Judge / IAU Field judge / International Judge Candidate / International Judge) till:
5. **Accreditation / reaccreditation:**
6. **Practical and technical experience** in IAU Field Crossbow Judging last four (4) years:
7. **Experience at IAU Championships:**
8. **Attendance of courses/seminars** held by the IAU:
9. **Name and address of the National Federation:**
10. **Signature of President** or Secretary General of National Federation:
11. **Signature of applicant:**
12. **Please supply** Two (2) photos 30x35mm and EUR 20 for IAU Judge license that will be paid to the IAU account.
13. Any additional information that could assist the IAU Field Technical Committee in evaluating the aptitude of the applicant.  
**Return form to: [office@iau-crossbow.org](mailto:office@iau-crossbow.org)**